

# PLATINUM TOOLS®

*We Make Connections EZ!™*



## Our Company

Platinum Tools, founded in 1997, was created based upon two very simple objectives. First, develop, manufacture, and source the absolute best possible solutions for the preparation, installation, hand termination, and test of wire and cable. Second, implement an operational infrastructure that can deliver these products in an efficient, timely, and high quality manner.

## Our Products

All of our products absolutely must satisfy three critical benchmark criteria...

- Utility of function
- Quality of function
- Economic value

## Our People

Our people are our company. They too must be focused on and work to satisfy three critical benchmark criteria...

- Customer satisfaction
- Product knowledge and expertise
- Willingness to learn and adapt





**Cutters** ————— 2-7



**Strippers** ————— 8-15



**Crimpers** ————— 16-27



**Punchdown** ————— 28-31

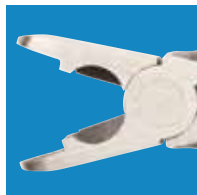

**Specialty Tools** — 32-39



**Connectors** ————— 40-51



**Structured Wiring** — 52-59

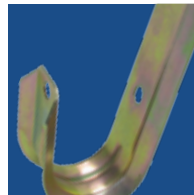

**Cable Management** - 60-65



**Test & Measurement** 66-87

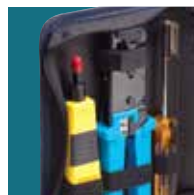

**Kits** ————— 88-97

**Index & Reference** 98-106

We Welcome OEM Applications

# Cutters



Part #	Description
10525C	Professional Electrician's Scissors

## Professional Electrician's Scissors

Designed for use in electrical, telephone, and datacom service applications. Ergonomically designed large ring provides more power, reduces fatigue and wrist strain. Fits comfortably in the power portion of the palm producing a cleaner, quicker cut with less effort. Bottom blade has serrated teeth the full length of the cutting edge to grip the cable/wire. Through hardened (RC59).

### Features

- Cuts stranded wire to 12 AWG
- Cuts solid wire to 16 AWG
- Trims Kevlar in fiber optic cable
- Strips 19 to 23 AWG wire
- Serrated edges on back of blades for cleaning wire and binding posts



Part #	Description
10517C	Scissor-Run Electrician's Scissors - 5"

## 5" Scissor-Run Electrician's Scissors

Our Scissor-Run Scissors are an original favorite. This smooth cutting action, scissor-run design is excellent for cutting Kevlar, foil, and wire. Cuts wire up to 16 AWG solid, 12 AWG stranded, and will strip 19 AWG and 23 AWG.

### Features

- Full serrated bottom blade for non-slip cutting
- Stripping notches for 19 and 23 AWG wire
- Double plated chrome over nickel
- Easily re-sharpens and holds cutting edge
- Scraper and file on backside of blades



10522C



10526C

## Leather Pouch, Knife, and Scissors Kits

These kits provide essential solutions for the professional installer. Includes a 6" nickel plated cable splicer's knife with a weighted handle and a comfortable, non-slip grip, and your choice of scissors in a durable leather belt pouch.

Part #	Description
10522C	Scissor-Run Electrician's Scissors Kit
10526C	Professional Electrician's Scissors Kit

10520C



10519C	Leather Pouch and Cable Splicer's Knife
10520C	Cable Splicer's Knife
10521C	Leather Belt Pouch

## Ceramic Kevlar® Scissors

The Ceramic Kevlar Scissors provide superior performance when trimming the Kevlar strength member in fiber optic cables; also works well with Kevlar cloth. The secret is the Zirconia ceramic blades that will not dull or lose their edge like stainless steel blade scissors. Large finger loops are comfortable and easy to manipulate.

### Features

- Cuts fiberglass aramid fibers
- Never needs sharpening
- Zirconia ceramic blades
- Large finger loops for ease of use

Part #	Description
10530C	Ceramic Kevlar® Scissors



## Kevlar® Fiber Optic Scissors

The best shears to cut fiber optic Kevlar. Also, a great tool to cut soft cables, electrical tape, aramid yarn, and Kevlar material.

### Features

- Easily cuts Kevlar
- Full serrated bottom blade for non-slip cutting
- Easily re-sharpens and holds cutting edge
- Ergonomic handles

Part #	Description
10529C	Kevlar® Fiber Optic Scissors



## Cut-N-Strip

The dual function Cut-N-Strip tool's small size and ease of use delivers superior performance and utility of function. The cutting jaws provide a low profile full-flush cut and are manufactured from induction hardened stainless steel for long life. The patented stripper in the handle self-adjusts to wire sizes of 26 AWG to 14 AWG. Catch, hold, and strip wire in one quick motion.

### Features

- Strips 26 AWG to 14 AWG
- Full-flush cutting jaws
- Self-adjusting stripping jaws, no stripping holes to locate
- For use on copper wire only

Part #	Description
10503	Cut-N-Strip





### 5" Side Cutting Pliers

The 5" Side Cutting Pliers are perfectly suited for field or production line work. Cut copper wire or trim leads with the full flush cutting blades. Manufactured from high carbon tool steel, precision ground, and hardened for long life. Molded comfort grip handle. Rust resistant black oxide finish.

#### Features

- Cuts copper wire and soft metals up to 16 AWG
- 21° full flush cut
- Spring action
- Comfort grip vinyl handle

Part #	Description
10531C	5" Side Cutting Pliers



### Coax and Round Wire Cable Cutter

This durable, economically priced cutter is designed to cut solid and stranded wire up to 8 AWG, and multi-conductor and coaxial cable up to 1/2" diameter. Features a curved, precision-ground blade that will not deform the conductors or dielectric. Stamped from high carbon tool steel and heat treated for long life.

#### Features

- Cuts solid and stranded wire up to 8 AWG
- Cuts multi-conductor cable up to 1/2" diameter
- Cuts coaxial cables without deforming the dielectric
- Spring loaded with locking latch

Part #	Description
10500C	Coax and Round Wire Cable Cutter



### BTP-6 Coax and Data Cable Cutter

The rugged, drop forged construction provides exceptional durability and professional results. Dual elliptical cutting blades are precision ground to provide low effort cutting of coaxial cables without deforming the dielectric. Cuts twisted pair cables, both UTP/STP, and a wide range of coax. Non-slip cushioned handles fit the hand and the tool pouch.

#### Features

- Cuts solid, stranded, and multi-conductor cables up to 6 AWG
- Cuts coaxial cables without deforming the dielectric
- Dual elliptical cutting blades

Part #	Description
10510C	BTP-6 Coax and Data Cable Cutter

## CCS-6 Cable Cutter

Finally, a compact cable cutter designed to cut coax cable with steel center conductor, including RG11. Also easily cuts through copper and aluminum cable including Cat5e UTP/STP and many more.

### Features

- Cuts RG11/7, RG59, RG6, RG6Q with steel center conductor
- Compact and lightweight
- Fully tested to 10,000 cuts on RG6 CCS (copper clad steel center conductor), with no degradation to the cutting blades
- Heat-treated, precision ground blades

Part #	Description
10514C	CCS-6 Cable Cutter



## Steel Wire Cutter

Heavy duty, high leverage design provides single-handed cutting action on a wide variety of hard to cut materials. Blade is designed to ensure a clean cut without pinching or crushing. Maintains concentricity to allow fittings and terminals to go on easily.

### Features

- Forged from chrome molybdenum and hardened to 58-60 HRC
- Rust resistant electrophoretic deposition finish
- Smooth spring action for easy, repetitive cutting
- Handles contoured for comfortable hand grip

Part #	Description
10512C	Steel Wire Cutter



## BTC-20 Cable Cutter

Heavy duty, high leverage design provides greater cutting capacity with no cable distortion. Made from chrome vanadium steel.

### Features

- Cuts up to 2/0 AWG (70mm<sup>2</sup>) soft copper
- Cuts up to 4/0 AWG (95mm<sup>2</sup>) aluminum
- Cuts up to 100 pair (group) or 24 AWG telephone cable
- Through hardened and vacuum heat treated for longer-lasting cut

Part #	Description
10540C	BTC-20 Cable Cutter

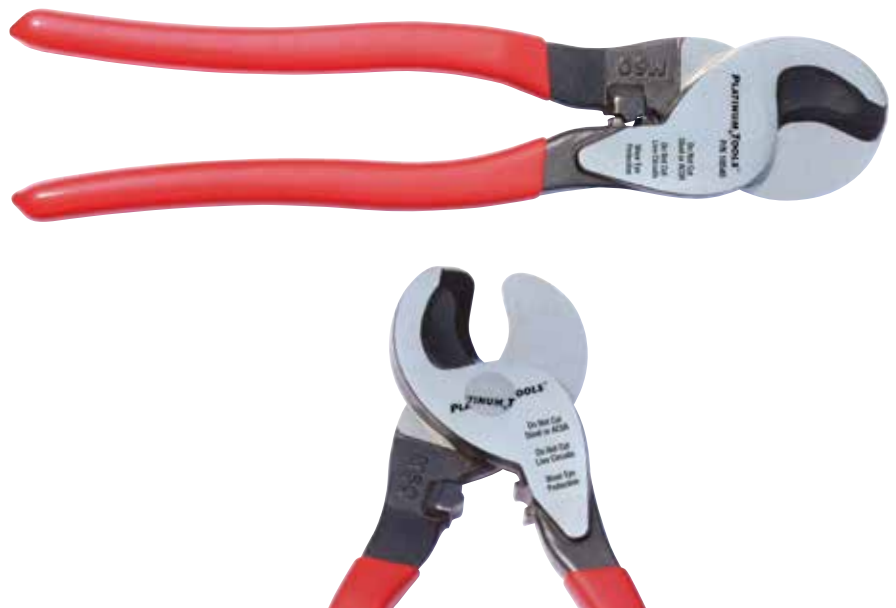



## 100 Pair Cable Cutter

This cable and wire cutter is a must for any tool belt when cutting larger diameter cables. Built to last – manufactured from precision ground, heat treated tool steel with rust resistant black oxide finish. Has a built-in return spring and locking latch for easy storage. Plastic molded ergonomic handles.

### Features

- Cuts to 100 pair (group) telephone cable
- Cuts solid or stranded cable to 2 AWG
- Cuts large diameter coaxial cable such as RG9U

Part #	Description
10550C	100 Pair Cable Cutter

## Wire Rope Cutter

Designed to cut wire rope of varied materials up to 6mm in diameter (3mm center steel). Jaw design ensures the cable will not unwind after cutting. Tool includes a crimping cavity in the handle for wire rope sleeves, allowing you to cut, loop, and crimp to secure or hang items with ease.

### Features

- Cuts up to 6mm wire rope (max 3mm center steel)
- Crimping cavity in handle for crimping wire rope sleeves
- Jaws ensure no unwinding after cutting

Part #	Description
10513C	Wire Rope Cutter



## 500 MCM Cable Cutter

This compact ratcheted cutter is designed for simple one hand operation. Works well in tight spaces. Cuts stranded, flexible copper, and aluminum cable up to 500 MCM (240mm<sup>2</sup>). Both fixed and moving cutting blades are precision ground. Cutting blades are manufactured from high carbon tool steel and heat treated for long life. Rust resistant black oxide finish.

### Features

- Cuts up to 500 MCM copper and aluminum cables
- Non-slip two-tone comfort grip handles
- Locking latch for easy storage
- Ergonomic handles
- Quick blade release system
- Designed for easy one handed operation

Part #	Description
10569C	500 MCM Cable Cutter
6055	Replacement Blade for P/N 10569C



## Ratcheted Telecom Cutter

This versatile cutter has a specially designed moving blade to handle larger diameter telephone cables. Cuts up to 2,700 pair telephone cable and up to 750 MCM (380mm<sup>2</sup>) soft drawn copper and aluminum cables. Cutting blades are manufactured from hardened tool steel for long life. The optional fixed handle cutting boot provides stability and increased leverage. Ratchet lock holds handles in closed position for storage. Rust resistant black oxide finish.

### Features

- Cuts up to 2,700 pair telephone cable
- Cuts up to 750 MCM copper and aluminum cables
- Quick blade release mechanism for safety and fast backout
- Locking latch for easy storage

Part #	Description
10560	Ratcheted Telecom Cutter - 2,700 Pair
6051	Replacement Blade for P/N 10560
1081	Fixed Handle Cutting Boot



### Tips & Tricks

## Give It The Boot

Cutting large diameter cables like 750 MCM can be a bear on your hand! Use the cutting boot (P/N 1081) to provide a stable platform for the cutter. Now you can put your weight behind the moving blade to improve your leverage... and save your hand!



## Ratcheted Utility Cutter

This compact ratcheted cutter is designed for simple, one hand operation. Cuts stranded, flexible copper, and aluminum cable up to 750 MCM (380mm<sup>2</sup>). The compact design works well in tight workspaces. Both fixed and moving cutting blades are precision ground. The optional fixed handle cutting boot provides stability and increased leverage. Cutting blades are manufactured from high carbon tool steel and heat treated for long life. Rust resistant black oxide finish.

### Features

- Cuts up to 750 MCM copper and aluminum cables
- Quick blade release mechanism
- Locking latch for easy storage

Part #	Description
10565	Ratcheted Utility Cutter - 750 MCM
6050	Replacement Blade for P/N 10565
1081	Fixed Handle Cutting Boot



# Strippers

## TOR Cable Jacket Stripper and Slitter

TOR is an adjustable heavy-duty cable stripping and slitting tool for all insulation types used in today's cables. Many of TOR's unique features include inter-changeable cable clamps, giving it a cable capacity up to 1 1/2" / 40mm. The durable TOR has been tested to over 100,000 cycles!

### Features

- Strips to a maximum OD of: 0.18" - 1.57" (4.5mm to 40mm)
- Easy to use: Positive locking positions for circular, lengthways, and spiral (apple peel) strips
- The blade automatically returns to its starting position at the end of a strip, reducing the possibility of broken blades
- No special tools required to interchange cable clamps
- Blade height adjuster is almost friction free, easy to rotate for fine blade height adjustment
- Ergonomic: Well balanced design with rests for thumb, index, and little fingers to ease raising the cable clamp
- Life Span: 100,000 cycles
- Eyelet built in base of tool for attaching a lanyard

Part #	Description
10017C	TOR Cable Jacket Stripper and Slitter
10018C	TOR Replacement Blade



**Blade Height Adjustor**  
Insulation Thickness:  
Up to 0.18" (4.5mm)



**Storage Compartment**  
for an extra blade  
(P/N 10018C sold separately).



**Cable Size Range Per Clamp:**  
0.18" - 1.0" (4.5 mm<sup>2</sup> – 25 mm<sup>2</sup>)  
0.8" - 1.5" (20 mm<sup>2</sup> – 40mm<sup>2</sup>)

**Two Tools In One!**  
No special tool required to interchange cable clamps.

## TOR continued

### Strip & Slit



### Apple Peel

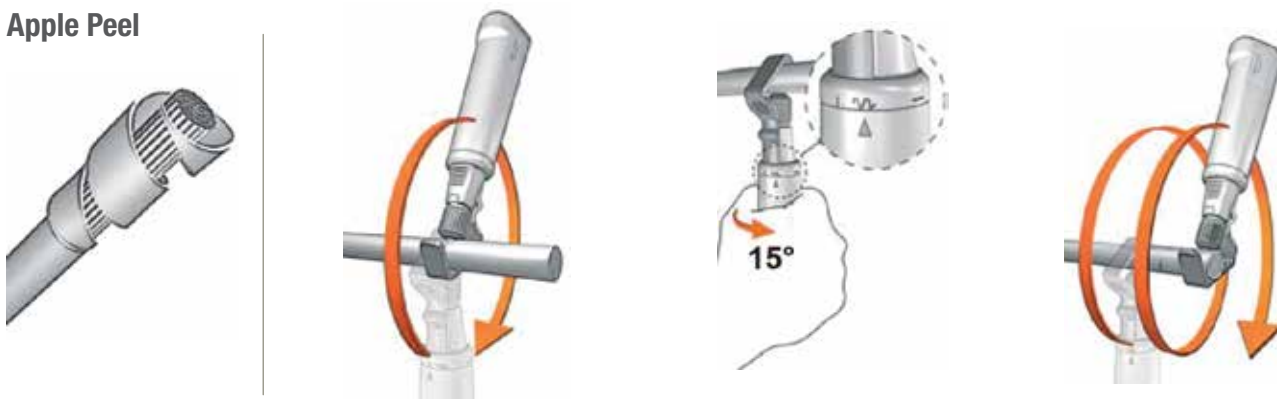

## Cable Jacket Slitter and Stripping Tools

Use the Cable Jacket Slitter for quick and precise removal of insulation from round cables without nicking conductors. Unique lever and blade design allows ringing, longitudinal, and spiral slitting of cable jackets. Cable holding bracket has integrated sharpened edge for removing insulation. Adjustable blade cutting depth; includes spare blade in the handle.

### Features

- Strips to a maximum OD of:
  - 0.18" - 1.0" (4.5mm<sup>2</sup> to 25mm<sup>2</sup>) – **P/N 10005C**
  - 1.0" - 1.4" (25mm<sup>2</sup> to 35.5mm<sup>2</sup>) – **P/N 10007C**
- Blade adjusts for jacket thickness to 0.125" (4.5mm)
- Use with stranded, solid, and multi conductor cable

### Applications

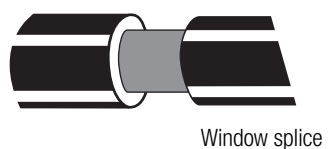
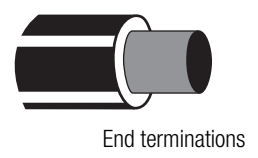
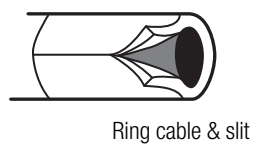

10005C

10007C

Part #	Description
10005C	Cable Jacket Slitter 0.18 – 1.0"
10007C	Cable Jacket Slitter 1.0 – 1.4"
10006C	Replacement Blade (2) for P/N 10005C and P/N 10007C

## Maxim® 6 and 16 Self-Adjusting Wire Strippers

Heavy duty, self-adjusting wire stripping and cutting tool. The ergonomic handle is designed for comfort and reduces fatigue. The auto form laminated stripping jaws form around the radius of the cable to ensure no damage to the inner conductor. Set adjustable wire stop for precise strip lengths. High leverage, built-in cutter with safety guard. Made from high grade polymers and carbon steels to ensure long life and reliable performance.

### Features

- For use with round, oval, and flat wire cable
- Maxim 6:
  - 24-10 AWG stripping range
  - 30-10 AWG cutting range
- Maxim 16:
  - 10-5 AWG stripping range
  - 10-5 AWG cutting range

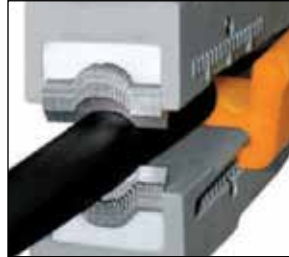

Laminated Blades



Wire Cutter



Adjustable Wire Stop

Part #	Description
15310C	Maxim® 6 Self-Adjusting Wire Stripper
15313	Replacement Blade Cassette for P/N 15310C

Part #	Description
15316	Maxim® 16 Self-Adjusting Wire Stripper
15317	Replacement Blade Cassette for P/N 15316



Replacement Blade Cassette P/N 15313



15316

15310C

## Minim<sup>®</sup> 2.5 Self-Adjusting Wire Stripper

High quality, self-adjusting wire stripping and cutting tool with a range of 30–13 AWG. Compact pistol grip design gives increased control and greater precision, vital for stripping smaller cables. The auto form laminated stripping jaws form around the radius of the cable to ensure no damage to the inner conductor. Adjustable wire stop for precise strip lengths. Made from high grade polymers and carbon steels to ensure long life and reliable performance.

### Features

- 30-13 AWG stripping range
- 30-13 AWG cutting range
- For use with round, oval, and flat wire cable

Part #	Description
15305C	Minim <sup>®</sup> 2.5 Self Adjusting Wire Stripper
15308	Replacement Blade Cassette for P/N 15305C



## ProStrip Wire Strippers

Designed to meet the demanding expectations of professionals. These wire strippers deliver performance, comfort, and consistent, reliable results. The tools can be used left or right handed – wire sizes are marked on both sides. Ergonomically designed handles require less hand force. The curved cutting blades ensure cleaner, precise cuts. Color-coded for quick identification.

### Features

- Precision-ground strip test
- Cut and chase threads on 16/32 and 8/32 bolts
- Serrated plier nose for gripping, pulling, and twisting
- Holes in jaw for looping wire
- Hardened to HRC45
- Rust resistant black oxide finish

Part #	Description
15003C	ProStrip 10/20 Wire Stripper
15005C	ProStrip 16/30 Wire Stripper





## V-Notch Wire Stripper

Designed with a precision ground V-notch blade for superior stripping results on various types of 24-10 AWG jacket insulations. Precision ground from high carbon steel, the stripping blades adjust to proper wire gauge with rotating cam wheel.

### Features

- Strip and cuts 24-10 AWG, solid or stranded wire
- Spring loaded with locking latch
- Looping holes for solid wire
- Vinyl dipped cushioned handles
- Hardened to HRC45
- Rust resistant black oxide coating

Part #	Description
15001C	V-Notch Wire Stripper

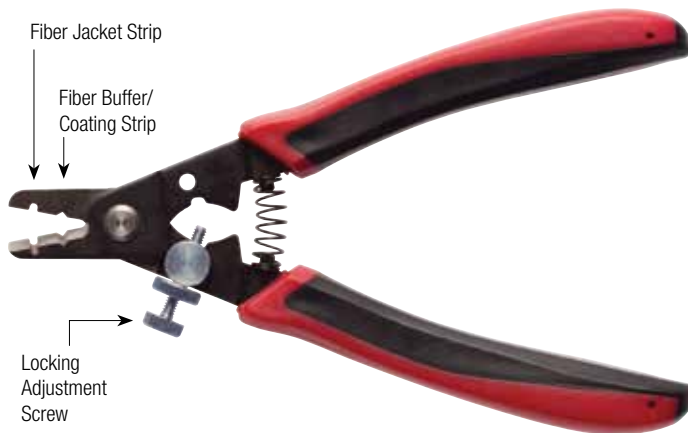

## Adjustable Fiber Optic Stripper

The Adjustable Fiber Optic Stripper is designed to be versatile and economical without compromising the needs of the professional installer. All stripping surfaces are precision ground and hardened for durability and long life. The circular notch strips a full range of outer fiber cable jacket insulations. The V-notch will strip/remove a full range of fiber buffer and coating materials. The adjustment screw allows for precise adjustments and locks into place once set.

### Features (See diagram)

- Use V-notch for stripping 250 $\mu$  to 500 $\mu$  fiber coatings (A)
- Use V-notch for stripping 500 $\mu$  to 900 $\mu$  tight buffer. (Loose Tube to 1500 $\mu$ ) (B)
- Use round notch for stripping outer cable jacket insulations to 3.0mm diameter (C)
- Cushioned grip handles provide positive, non-slip, comfortable operation

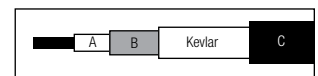

Part #	Description
15060C	Adjustable Fiber Optic Stripper

## 5-in-1 Fiber Optic Stripper

Work with a multitude of fiber optic cables. The pre-set design ensures all cavities are precision set and no adjustments needed, great for working in the field.

### Features

- Use for stripping multitude of fiber optic cables
- Cushioned grip handles provide positive non-slip, comfortable operation
- Precision ground stripping cavities
- Factory set and calibrated
- Strips outer jacket from 2.0 – 2.4mm fiber, 2.8 – 3.0mm fiber and 2.0 – 3.0mm loose tube buffer tubes
- Strips 900mm buffer and 250mm acrylate coating



Part #	Description
15061C	5-in-1 Fiber Optic Stripper

## Cat5e/6 Cable Jacket Stripper

This economical tool strips the cable jacket from Cat5e/6 twisted pair cables with professional results. Features a long life blade specifically designed to self-adjust to prevent nicks to the inner conductors. Durable, high impact plastic housing is molded in yellow to make it easy to locate.

### Features

- Removes the cable jacket on Cat5e/6 cables
- Accepts cable diameters from 0.18" to 0.25" (4.5mm<sup>2</sup> – 6.3mm<sup>2</sup>)
- No adjustments required; easily switch from one cable type or insulation to another
- Does not nick inner conductors
- Recommended for PVC cable jackets



Part #	Description
15015C	Cat5e/6 Cable Jacket Stripper

## Cyclops® 2 Cable Jacket Stripper

The Cyclops 2 takes the guesswork out of removing the jacket from many cable types including: twisted pair, multicore, and fiber optic cables. The tool self-adjusts to automatically score PVC, plenum, and other insulation types without damaging the braids, foils, or conductors. One piece design, ready to use right out of the package. Typical applications are in data, voice, video, audio, security, and others.

### Features

- Removes cable jackets from:
  - Twisted pair (shielded and unshielded) cables
  - Single and multi-core cables (shielded and unshielded)
  - Fiber optic cable
- Self-adjusting
- Accepts cable diameters from 0.10" to 0.43" (2.5mm<sup>2</sup> – 11mm<sup>2</sup>)



Part #	Description
15010C	Cyclops® 2 Cable Jacket Stripper

## BR1 Multi-Stripper

Easy to use, "Big Red" cuts and strips most cable types/sizes making it the pro's choice in the voice, data, and video-networking world.

### Features

- Works with most cable types/sizes including:
  - **Coax (Video):** RG59 CCTV, RG6 and RG6 Quad, RG7/11  
Includes braid comb for folding braid back over the cable jacket
  - **Twisted Pair (Data) PVC and Plenum:** Cat3/4, Cat5e shielded, Cat6, Cat6 shielded, Cat6A shielded
  - **Telephone and Audio (Voice):** Round cable
- Coax blades are preset, replacement cassettes available
- Adjustable cable jacket stripper for voice/data
- Built-in cable cutter, not for steel



Strips all these



Part #	Description
15041C	BR1 Multi-Stripper
15042C	Replacement Blade Cassette
15041BLC	Replacement Blade Set (2)

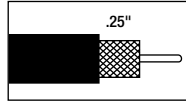

Part #	Description
15020C	Double-Ended Coax Stripper

## Double-Ended Coax Stripper

Quickly and easily strips a broad range of coax cables in a single step without any adjustments. The blades are designed to produce the standard 1/4" braid, 2-level strip for compression connectors.

### Features

- Works with RG7/11/213/8 and RG59/6/6Q cables
- Quickly removes cable jacket and dielectric
- Preset, requires no adjustments
- Compact, lightweight, and simple operation



Part #	Description	Tool & Connector Color
15021C	SealSmart™ Coax Stripper for RG6 Quad	(Blue) ●
15022C	SealSmart™ Coax Stripper for RG6	(Black) ●
15023C	SealSmart™ Coax Stripper for RG59	(Red) ●

## SealSmart™ Coax Cable Strippers

SealSmart Coax Strippers are factory preset for specific cable sizes. Delivers fast, accurate results right out of the box. Color-coded by cable type to coordinate with the SealSmart Compression Connectors.

### Features

- Preset, requires no adjustments
- 1/4" braid, 2 level strip
- Meets industry standard for all compression connectors

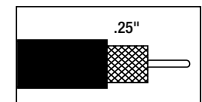

Part #	Description	Connector Color
15024C	SealSmart™ Coax Stripper for Mini RG59 (Navy Blue)	●

## SealSmart™ Mini RG59 Stripper

This SealSmart Coax Cable Stripper is factory preset for Mini RG59 cable. It works on 23 AWG solid center conductor cable.

### Features

- 1/4" braid, 2 level strip
- Preset, no adjustment required
- Prep coax for SealSmart 23 AWG center conductor F, RCA, and BNC compression connectors with the navy blue color code

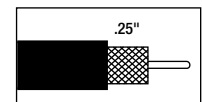



## ProStrip 25R Coax Stripper

Designed for the professional contractor. Factory preset for industry standard 1/4" cable preparation, eliminating the need for time consuming blade depth adjustments. Stainless steel rollers provide smoother, concentric, non-binding rotation on a wide range of cables for fast, professional results. No adjustments required!

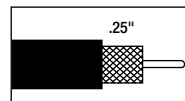

### Features

- Includes 2 stripping ports for a broader range of cables:
  - RG6 and RG59
  - RGB/Mini 59 for 23, 24, and 25 AWG
- Industry standard 1/4" strip length
- Preset, quick-change blade cartridges
- Rugged, high impact plastic housing
- Long life stainless steel blades

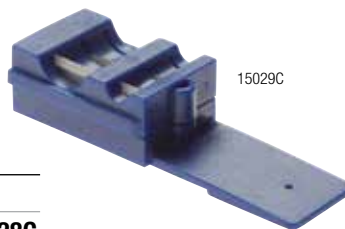

Stainless Steel Rollers

Part #	Description
15028C	ProStrip 25R Coax Stripper
15029C	Replacement Blade Cartridge for P/N 15028C

## E Series Coax Cable Strippers

The E Series Coax Cable Strippers are simple to operate and ensure a professional, repeatable strip every time. All strippers include a hex wrench for adjustable blade depth. Stripping lengths are also adjustable.

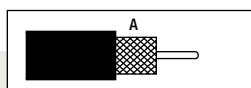

### 2-Level Stripping

- Factory presetting: Shield dimension (A) 6mm (0.236")
- Adjustable to additional settings: 4, 8, and 12mm (0.157 / 0.315 / 0.472")

Part #	Description
15030C	Coax Cable Stripper, 2-Level RG58/59/62/6/6Q
15031C	Coax Cable Stripper, 2-Level RG58/59/62
15032C	Coax Cable Stripper, 2-Level RG59/62/6
15038C	Replacement Blades (2), for 2-Level Strippers

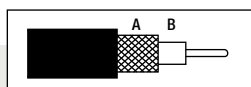

### 3-Level Stripping

- Factory presetting: Shield Dimension (A) 8mm (0.315"); Dielectric (B) 4mm (0.157")

Part #	Description
15033C	Coax Cable Stripper, 3-Level RG58/59/62
15034C	Coax Cable Stripper, 3-Level RG59/62/6/6Q
15035C	Coax Cable Stripper, 3-Level RG7/8/11/213/214
15039C	Replacement Blades (2), for 3-Level Strippers

### Features

- Works with RG58/59/62/6/6 Quad coax cables
- Adjustable stripping depth for various insulation types and thicknesses
- Preset for 6mm (referred to as the 1/4" strip) but adjusts to additional dimensions
- Uses drop-in replacement blades, no cassettes required
- Hex wrench snaps into housing for convenient storage
- Molded from high impact plastic for long life



15030C

#### 2-Level Adjustment



#### 3-Level Adjustment



# Crimp Tools

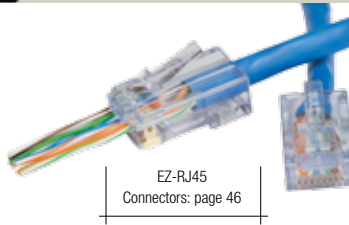

## EXO Crimp Frame® with EZ-RJ45® Die – compatible with EZ-RJ45 connectors

Patented EXO Crimp Frame and EZ-RJ45 Die designed for terminating EZ-RJ45 connectors. The included EZ-RJ45 Die is interchangeable and reversible when used with EXO Crimp Frame. Designed for the original pass through EZ-RJ45 connectors which are a standard in the industry. The EXO Crimp Frame highlights a push button lock, ergonomic TPR handles, and works with the EXO-EX Die (P/N 100071C) for terminating ezEX-RJ45 connectors.

### Features

- Single cycle crimp and flush trim
- EZ-RJ45 Die is easily interchangeable
- Reversible EZ-RJ45 Die for ambidextrous operation
- Connectors lock into tool for correct positioning during crimp
- Push button lock for easy storage
- Ergonomic comfort grip TPR handles
- Includes the EZ-RJ45 Die for crimping EZ-RJ45 connectors
- Compatible with EZ-RJ45 connectors: EZ-RJ45 Cat5e and Cat6, Shielded Cat5e and Cat6 connectors (internal and external ground)

Part #	Description	Compatible Connectors
100062C	EXO Crimp Frame with EZ-RJ45® Die	EZ-RJ45® Connectors
100072C	EZ-RJ45® Die only	EZ-RJ45® Connectors
100072BL	EZ-RJ45® Die Blade (2)	EZ-RJ45® Connectors

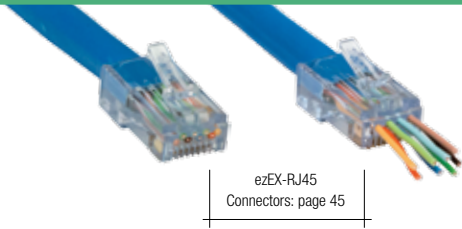

## EXO Crimp Frame® with EXO-EX Die™ – compatible with ezEX-RJ45® connectors

Patented EXO Crimp Frame and EXO-EX Die developed to terminate larger cables and conductors (typically Cat6/6A). The EXO Crimp Frame and EXO-EX Die is designed for the ezEX-RJ45 connectors. The ezEX-RJ45 connectors are an RJ45 pass through connector, developed for larger cables and conductors. Integrated Hi-Lo stagger for improved performance, one piece design pass through system. The EXO Crimp Frame has a patented push button lock, ergonomic TPR handles and works with the EZ-RJ45 Die (P/N 100072C) for terminating EZ-RJ45 connectors.

### Features

- Single cycle crimp and flush trim
- EXO-EX Die is easily interchangeable
- Reversible EXO-EX Die for ambidextrous operation
- Connectors lock into tool for correct positioning during crimp
- Push button lock for easy storage
- Ergonomic comfort grip TPR handles
- Includes EXO-EX Die for crimping ezEX44 and ezEX48 connectors
- Terminates larger cables and conductors, such as Cat6 and Cat6A

### ezEX-RJ45 Connectors

- Simple one piece/pass through design, no bars or liners
- Rated up to 10 Gigabit for superior performance
- Works with solid or stranded conductors from 24-22 AWG
- FCC, RoHS 2, and UL compliant

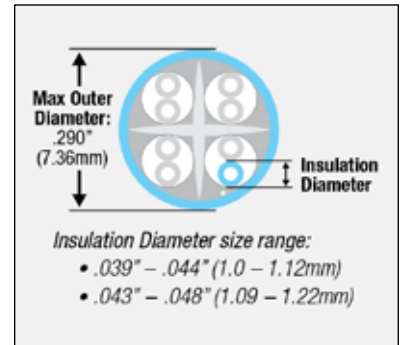

Part #	Description	Compatible Connectors
100061C	EXO Crimp Frame® with EXO-EX Die™	ezEX-RJ45® Connectors
100071C	EXO-EX Die only	ezEX-RJ45® Connectors
100071BL	EXO-EX Die Blades (2)	ezEX-RJ45® Connectors

Die Back  
(Connector Insert)



Die Front  
(Wire Cutter)





## EZ-RJPRO™ HD Crimp Tool

The EZ revolution continues – the EZ-RJPRO HD Crimp Tool is designed for the professional installer demanding consistent, reliable, and repeatable terminations, every time. This heavy duty tool is the perfect solution when working with high performance, larger OD cables that are tougher to terminate due to larger wire gauges, thicker, harder insulation, and pair separating splines. Overcome these connectivity obstacles and be assured that every termination will meet FCC specifications.

### Features

- Compatible with all EZ-RJ45 and EZ-RJ12/11 connectors as well as all standard modular plugs, except AMP
- Ratcheted, high leverage, and stable platform for consistent, repeatable terminations
- Patented “crimp and trim system” delivers a clean, flush trim on the extended conductors for all EZ connectors
- Zero flex frame prevents torque loss
- Tooled steel die head assembly provides 360° of connector support
- Full surface to surface contact delivers uniform crimp force
- Built-in cutter and stripper for flat and round cable
- Laser marked with wiring guide for proper wire sequence

Part #	Description
<b>100054C</b>	<b>EZ-RJPRO™ HD Crimp Tool</b>
<b>100054BL</b>	<b>Replacement Blade Set for P/N 100054C</b>
<b>100054SBL-10C</b>	<b>Replacement Blade Set for P/N 100054C, Pack of 10</b>

## EZ-RJ45® Crimp Tool

This high quality crimp tool is designed to quickly crimp and cut the wires of the EZ-RJ45 connector in one easy simple operation! The ratcheted straight action crimping motion ensures a uniform crimp every cycle. Features precision cast crimping dies for superior accuracy. Built-in wire cutter and stripper for silver satin. All steel frame with rust resistant black oxide finish.

### Features

- For use with EZ-RJ45 Cat5/5e and Cat6 connectors
- Crimps and trims extended wire in EZ-RJ45 connectors in a single cycle
- Features precision cast crimping dies for superior accuracy
- Built-in wire cutter and stripper for silver satin
- Laser marked with wiring guide for proper wire sequence
- Also compatible with all standard modular plugs (except AMP)

<b>100004C</b>	<b>EZ-RJ45® Crimp Tool</b>
<b>100004BL</b>	<b>Replacement Blade (2) for P/N 100004C</b>

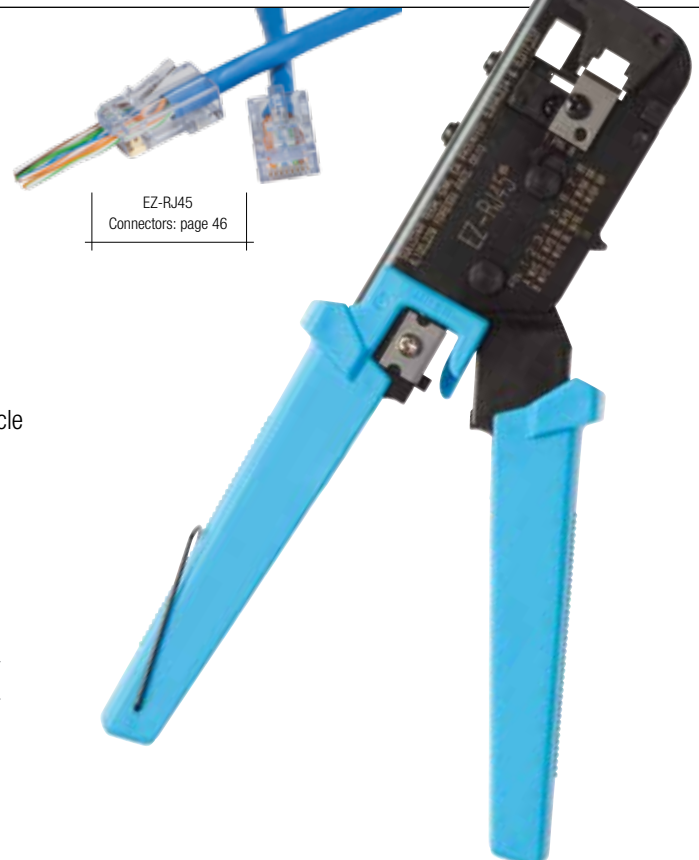



## EZ-Viking™ Crimp Tool

The patented EZ-Viking Crimp Tool was developed to meet the most demanding network performance. This single function professional crimp tool is precision manufactured to the highest international standards and delivers the highest quality, consistent modular plug terminations available. Applications include high-end data centers, aerospace, and broadcast.

### Features

- Optimizes termination of EZ-RJ45 Cat5e/6 regular/shielded and external/internal ground connectors
- Parallel action for precision crimping
- Ergonomic, pistol grip ratchet action for full crimp cycle
- Highest quality and durability – minimum of 50,000 cycles
- Zero flex frame prevents torque loss during the crimping cycle
- Tool steel die provides 360° connector support during crimp for tighter tolerances
- Flush trim on the EZ-RJ45 extended conductors
- Factory set with precise eccentric cam adjustment
- Safety release
- Made in Sweden



### P/N 100543K1

- Blade Spacer
- Blade
- Blade Return Springs
- 6" Safety Wire (0.02" Dia)
- Blade Retention Nuts
- Blade Retention Springs

Part #	Description
100544	EZ-Viking™ Crimp Tool
100543	EZ-RJ45® Crimp Die Set for P/N 100544
100543BL	Replacement Blade for P/N 100543
100543K1	EZ-Viking™ Field Service Kit

## Tele-TitanXg™ Modular Plug Crimp Tool

This professional crimp tool fits comfortably in your hand or your pocket. The straight action termination delivers even pressure on each of the modular plug's pins ensuring precise termination. Its superior fit and function consistently meet your performance requirements.

### Features

- Specifically designed for RJ45 Cat6A 10Gig shielded connectors (*Not for standard RJ45 modular plugs*)
- Minimal hand force
- Straight action crimp
- Compact and rugged
- Terminates to industry specified crimp heights
- Stays securely closed with gun-style lock
- Built-in cable stripper for round wire and flat satin
- Easily control the blade depth when stripping
- Built-in cable cutter

Part #	Description
12515C	Tele-TitanXg™ Modular Plug Crimp Tool
12507BLC	Replacement Blade Set for P/N 12515C



## Tele-TitanXg™ 2.0 Modular Plug Crimp Tool

The next generation in our 10Gig Termination System combines two crimpers into a single tool, making 2-step crimping simple. Insert the connector into the front end to terminate the contacts and switch to the back end to crimp the external ground. Like the original, the new Tele-TitanXg 2.0, along with our 10Gig Shielded Connectors, are engineered specifically for Cat6A cables to provide true 10Gig performance each and every time.



Cat6A 10Gig Shielded RJ45 Connectors: page 49

### Features

- One tool does the job of two tools
- Improve efficiencies by not having to change out tools in the middle of your termination
- Straight action crimp achieved with minimal hand force
- Compact and rugged design
- Terminates to industry specified crimp heights
- Gun-style lock for secure closure
- Non-slip handle and finger grooves for comfortable grip and control
- *Not to be used on standard RJ45 modular plugs*

## Tele-Titan™ Xg 2.0

The Cat6A 10Gig Termination Solution!

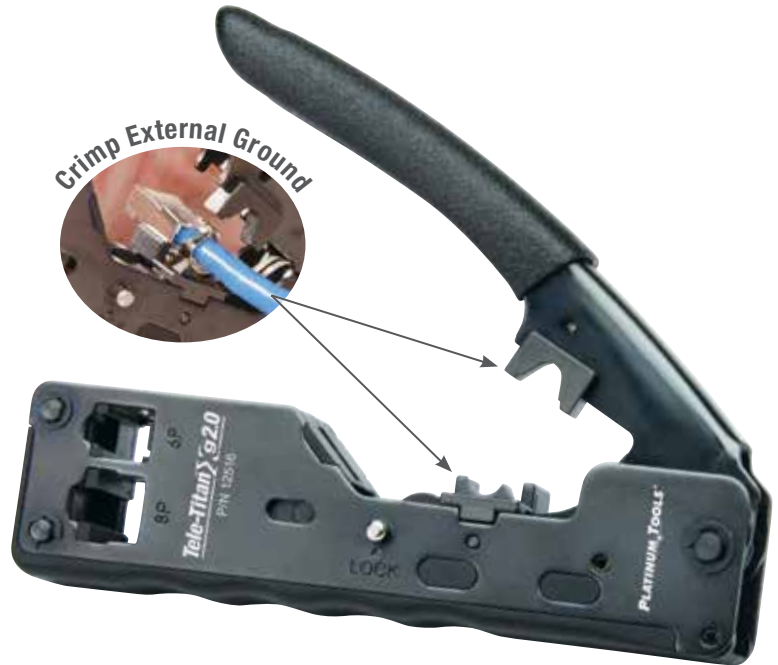

### Application

- RJ45 Cat6A 10Gig Shielded RJ45 connectors
- Cat6E, Cat6A, Cat7, and over-sized Cat5e/6 Industrial Ethernet Cables
- RJ12/11 connectors

Part #	Description
12516C	Tele-TitanXg™ 2.0 Crimp Tool
12517C	Tele-Titan Xg™ 2.0 Combo 10-Pack

## CT-360 External Ground Crimp Tool

Crimps 360° on the external ground tab of shielded RJ45 connectors. Tool design allows the installer to perform a concentric termination with full control, preventing over/under crimping.

### Features

- Non-ratcheted design
- Dual cavity covers wide range of cable ODs
- Spring loaded
- Simple design, easy to use
- Works on most external ground tabs
- All steel frame
- Black oxide finish



Part #	Description
12360C	CT-360 External Ground Crimp Tool



## Tele-Titan™ Modular Plug Crimp Tool

This professional crimp tool fits comfortably in your hand or pocket. The straight action termination delivers even pressure on each of the modular plug's pins ensuring precise termination. Its superior fit and function consistently meet your performance requirements.

### Features

- Rugged – for professional use and reliability
- Crimps with minimal hand force
- Lightweight and half the size of a standard crimp tool
- Stays securely closed for storage with “gun safety lock-style” design
- Embedded cable strippers for round & flat cables; built-in cable cutter

Connectors: pages 48-49

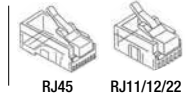

Part #	Description
12507C	Tele-Titan™ Modular Plug Crimp Tool
12507BLC	Replacement Blade Set for P/N 12507C
12508C	Tele-Titan™ Combo Pack

### 12508C Combo contents:

- Tele-Titan Modular Plug Crimp Tool, P/N 12507C
- RJ45 Cat5e connectors (10)
- RJ11 connectors (10)



## All-In-One Modular Plug Crimp Tool

Combines a rugged design with multi-purpose functions for all telecom and network installers working with RJ45, RJ12, RJ11, and RJ22 (handset) modular plugs. Manufactured to provide reliable terminations every time.

### Features

- Works with RJ45/12/11/22 modular plugs with Cat5, Cat5e, and Cat6 cables
- Three separate crimp cavities for 4, 6, and 8 position modular plugs
- Ratchet mechanism with quick release assures optimum termination
- Built-in round and flat (silver satin) cable strippers and cable cutter
- All steel frame with rust resistant black oxide finish; rugged PVC handles

Connectors: pages 48-49

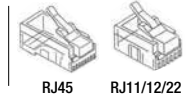

Part #	Description
12503C	All-In-One Modular Plug Crimp Tool
12503BLC	Replacement Blade Set for P/N 12503C

## PROAMP™ Crimp Tool

The PROAMP Crimp Tool is designed for installing AMP style modular plugs. The platform provides reliable, repeatable terminations every time. This heavy duty tool is the perfect solution when working with high performance, bigger OD cables that are tougher to terminate due to larger wire gauges, thicker, harder insulation, and pair separating splines. Overcome these connectivity obstacles and be assured that every termination will meet FCC specifications.

### Features

- Crimps AMP style RJ45, RJ12, and RJ11 modular plugs; solid, stranded, unshielded (UTP), and shielded (STP)
- Die head assembly manufactured from tool steel
- Provides 360° of connector support during crimp cycle – expanded surface area on contact drivers delivers full, uniform crimp force
- Built-in cutter and cable jacket strippers (for round and flat cables)

Part #	Description
100055C	PROAMP™ Crimp Tool
100055BL	Replacement Blade Set for P/N 100055C

## SealSmart™ Compression Crimp Tool

The original SealSmart provides simple, fast, and reliable terminations for F, RCA, and BNC compression style connectors. It's the perfect solution for CATV, DSS, security, and residential structured wiring installations. Connector adapters mount in handle for easy storage. Straight action mechanism provides uniform compression.



### Features

- Crimps F, RCA, BNC, and right angle compression style connectors – simply insert proper adapter
- Use on RG59, RG6, and RG6Q shielded cables
- Adjustable crimp stroke enables tool to work with SealSmart and other manufacturers' compression connectors
- F, RCA, and BNC connector crimping adapters included (spare adapters available)

Part #	Description
16201C	SealSmart™ Compression Crimp Tool
16202C	BNC Adapter & Nut
16203C	F Adapter & Nut
16204C	RCA Adapter & Nut

## SealSmart™ II Compression Crimp Tool

Easily terminate F, RCA, and BNC compression style connectors without changing adapters. The universal head easily adjusts to the proper crimp stroke, making it compatible with most standard compression connectors.

### Features

- Crimps all standard F, RCA, BNC, and right-angle compression style connectors
- Works with RG59, RG6, RG6Q, and mini RGB coax cables
- Lock washer holds head in place once adjusted to proper crimp stroke

Part #	Description
16220C	SealSmart™ II Compression Crimp Tool



## F Connector Compression Crimp Tool

This professional quality tool will withstand the rigors of continuous field use. Manufactured from tool steel and chrome plated with non-slip vinyl grip. At only 5 ½" long, its small compact design fits and feels right in the hand. Works great when terminating F connectors inside a panel box.

### Features

- Crimps compression F connectors onto RG6Q/RG6/RG59 coax
- Small compact design, 5 ½" long
- Great for working in tight spaces
- Tool locks in the closed position when not in use

Part #	Description
16207C	F Compression Crimp Tool





## SealSmart™ PROCON Compression Crimp Tool

The newest addition to the SealSmart product line is designed for professional contractors installing CATV and CCTV networks who need quick, reliable results every time. Engineered for long life, this rugged tool features a patented rotating connector positioner-head and multi-head adapter.

### Features

- Head rotates from RG6Q/6/59 to RG11/7
- Connector positioner accepts F, BNC, or RCA
- Adjustable crimp stroke accommodates standard compression F, BNC, RCA, and right angle connectors
- High carbon tool steel frame
- Comfortable, molded handle

Part #	Description
16213C	SealSmart™ PROCON Compression Crimp Tool
16215C	Replacement Multi-Head Adapter for P/N 16213C

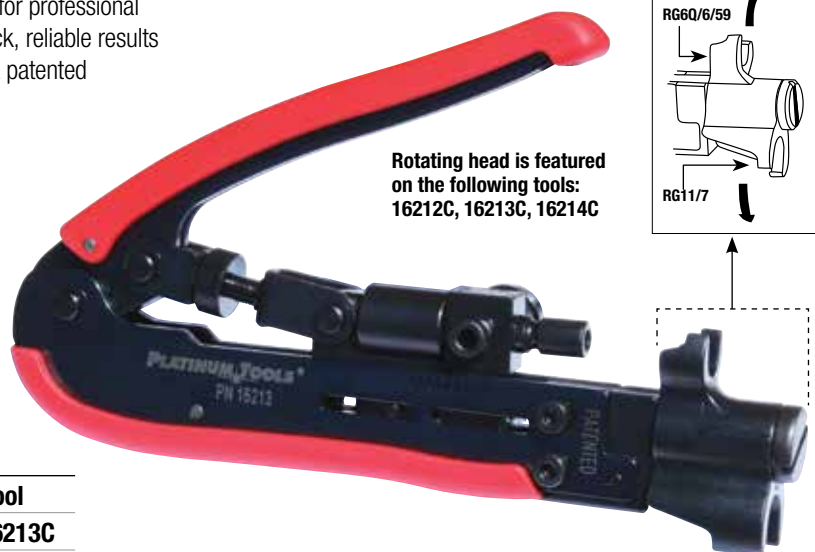

## SealSmart™ RH360L F Compression Tool – Long Stroke

This rugged tool is designed for the CATV installation contractor. Patented rotating head allows for quick change between RG11/7 and RG59/6/6Q with no adjustments required. Crimp height is fixed for most other brands of connectors with similar compression length meeting the industry standard when fully compressed.

### Features

- Crimps SealSmart F connectors on RG59/6/6Q and RG11/7 coax cables
- Works with most other brands of compression F connectors with similar length on RG59/6/6Q and RG11/7 coax cables
- Molded cushioned handle for comfort
- High carbon tool steel frame with black oxide rust resistant finish



Part #	Description
16212C	SealSmart™ RH360L F Compression Tool - Long Stroke

## SealSmart™ RH360S F Compression Tool – Short Stroke

This rugged tool is designed for the CATV installation contractor using short type EX compression F fittings. Patented rotating head allows for quick change between RG11/7 and RG59/6/6Q without adjusting tool. Crimp height is fixed for PPC Aquatight® connector “EX or short version” compression fittings and others with similar compression length.

### Features

- For crimping short type EX compression F connector fittings on RG59/6/6Q, RG/11/7, and QR320 coax
- Comfortable, molded cushioned handle
- High carbon tool steel frame with black oxide rust resistant finish



Part #	Description
16214C	SealSmart™ RH360S F Compression Tool - Short Stroke

## 9" Ergo Crimp Tool

Here's the next generation of crimp tool technology designed around the user. Crimping is even easier and more comfortable. The "straight plate" lower jaw assembly eliminates critical structural stress points, common in most competitive tools – it will not break under heavy stress and will last for years to come. Higher performance, reliability, and comfort, it's all here.















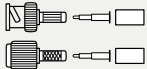

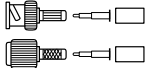



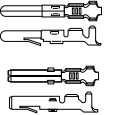

### Features

- Crimps insulated terminals to 10 AWG and non-insulated terminals to 8 AWG
- Variety of crimp dies available for CATV F, BNC, TNC, SMB, SMA, and N series coaxial connectors
- Accepts crimp die sets from most other popular tools. Your old crimping dies will work!
- Reduced handle grip distance makes it ideal for all hand sizes and allows for prolonged, comfortable use
- Smooth, ratcheted crimp cycle with a safety release and no break over hand force
- Adjustable cam for precision ratchet adjustment, allowing for a perfect crimp, no matter the die set or application

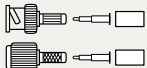
Part #	Description
16500C	9" Ergo Crimp Tool, Frame Only
17099C	Quick Change Die Screws (2)

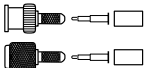

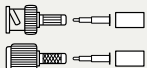
## 9" Ergo Crimp Tool Dies and Applications

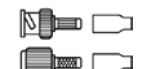
Die	Crimp	Part # Tool & Die / Die Only	Cable Types	Crimp Type/Sizes	Connector Types
		<b>16501C / 17051C</b>	22-10 AWG Solid or Stranded	3 Cavity 22-18 AWG (0.34 – 0.75mm <sup>2</sup> ) 16-14 AWG (1.5 – 2.5mm <sup>2</sup> ) 12-10 AWG (4 – 6mm <sup>2</sup> )	Heavy Duty Insulated Terminals and Lugs
		<b>16502C / 17052C</b>	22-8 AWG Solid or Stranded	4 Cavity 22-18 AWG (0.34 – 0.75mm <sup>2</sup> ) 16-14 AWG (1.5 – 2.5mm <sup>2</sup> ) 12-10 AWG (4 – 6mm <sup>2</sup> ) 8 AWG (10mm <sup>2</sup> )	Non-Insulated Terminals
		<b>16503C / 17053C</b>	RG59/6 Belden 8281/1694A	Hex 0.042 / 0.068 / 0.255 / 0.324	BNC, TNC, HDTV
		<b>16504C / 17054C</b>	RG58, RG59, RG62	Hex 0.068 / 0.213 / 0.255	BNC, TNC 3 Piece
		<b>16505C / 17055C</b>	RG59, RG6	Hex 0.256 / 0.315 / 0.346	F Type, 1 & 2 Piece CATV
		<b>16506C / 17056C</b>	RG6, RG6Q, 8281 1694A, 1695, 1505, 9259, 9231	Hex 0.360 / 0.324 / 0.068	BNC, TNC, F Type
		<b>16507C / 17057C</b>	22-10 AWG Solid or Stranded	3 Cavity 22-18 AWG (0.34 – 0.75mm <sup>2</sup> ) 16-14 AWG (2.5 – 1.5mm <sup>2</sup> ) 12-10 AWG (4 – 6mm <sup>2</sup> )	Standard Duty Commercial Insulated Terminals & Lugs
		<b>16508C / 17058C</b>	22-10 AWG Stranded	3 Cavity 22-18 AWG (0.34 – 0.75mm <sup>2</sup> ) 16-14 AWG (2.5 – 1.5mm <sup>2</sup> ) 12-10 AWG (4 – 6mm <sup>2</sup> )	Commercial Pin & Socket Type Contacts, Open Barrel Contacts, Box Contacts
		<b>16509C / 17059C</b>	RG174, 187, 188, 316 Mini Coaxial	Hex 0.178 / 0.128 / 0.068	SMA, SMB, Mini 59, BNC, TNC, Mini UHF
		<b>16510C / 17060C</b>	RG8, RG11, RG213, RG214, LMR400	Hex 0.429 / 0.100 / 0.080	N Type Plugs
		<b>16511C / 17061C</b>	RG59/62, 734, 735, RG6	Hex 0.311 / 0.256 / 0.200 / 0.068 / 0.039	HDTV, True 75 Ohm BNC, TNC
		<b>16512C / 17062C</b>	RG6/6TFE/59/ 59TFE/58	Hex 0.320 / 0.264 / 0.250 / 0.212	Universal 2-Piece BNC, TNC with 2-Step Ferrule & Captive Contact

Contact us about custom dies.



## 8" Crimp Tool

Features comfortable, ergonomically designed handle grips with a smaller handle spread. The tool's light weight and compact design is very popular in the higher production environments. Perfectly suited for hard to handle open barrel contacts and fiber optic connectors. Crimp release lever improves throughput by eliminating rejected terminations resulting from improper connector positioning. Accepts crimp die sets from a wide variety of manufacturers.

### Features

- Full cycle ratchet mechanism
- Quick release lever
- Smaller handle spread
- Accepts die sets from a variety of manufacturers

Part #	Description
16000C	8" Crimp Tool, Frame Only

## 8" Crimp Tool Dies and Applications

Die	Crimp	Part # <small>Tool &amp; Die / Die Only</small>	Cable Types	Crimp Type/Sizes	Connector Types
		16001C / 16051C	Fiber Optic	Hex 0.151 / 0.178 / 0.213	Fiber Optic SMA, ST, SC, FC
		16003C / 16053C	Fiber Optic	Hex 0.128 / 0.151 / 0.178	Fiber Optic SMA, ST, SC
		16004C / 16054C	24-12 AWG Stranded	2 Cavity 24-20, 18-14 AWG	Open Barrel Contacts
		16005C / 16055C	30-18 AWG Stranded	2 Cavity 30-24, 22-18 AWG	Open Barrel D-Sub, RS232 Pin & Socket Contacts
		16006C / 16056C	16 AWG Stranded	2 Cavity Male / Female Contact	Open Barrel Pin & Socket Contacts w/ Waterproof Gasket
		16007C / 16057C	22-10 AWG Solid or Stranded	5 Cavity 22-10 AWG	DIN & US Type Wire Ferrules (Cord End Terminals)

## Terminal Crimp Tool

Designed and manufactured to provide superior performance, durability, and value. It features dual crimping cavities for insulated and non-insulated terminals and splices. The thin tapered nose assists when working in confined areas.

### Features

- Crimp non-insulated terminals and splices from 10-22 AWG
- Crimp insulated terminals and splices from 10-22 AWG
- Precision ground and hardened cutting blade
- Drop forged from chrome vanadium steel alloy to prevent rust
- Comfort grip dipped handles
- Cuts copper and aluminum wire up to 10 AWG *(not suitable for cutting steel)*
- High leverage, 9.75" long



Part #	Description
12150C	Terminal Crimp Tool

## Open Barrel Contact Crimp Tool

Simultaneously performs electrical and strain relief crimps of 24-18 AWG open barrel contact pins. Crimping cavities are precision ground and heat treated for long life.

### Features

- 24-22 AWG and 20-18 AWG wire ranges
- Spring loaded for ease of use and locking latch for storage
- Soft, comfortable molded handles
- Built-in wire cutter

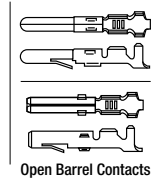

Part #	Description
16801C	Open Barrel Contact Crimp Tool



## 4-Way, 8 and 12 Point Indent Crimp Tools

An economical alternative to MIL-SPEC® (MS22520) approved crimping tools. Providing a higher level of reliability and greater pull strength, the dies are precision machined from tool steel and heat treated for long life. The tools feature a full cycle ratchet mechanism and include a built-in contact locator.

### Features

- 4-Way, 8 point, or 12 point indent crimping styles
- Wire range: 26 - 20 AWG
- For use on solid barrel type contacts used in RS-232 style connectors
- For use on BNC/TNC solid barrel center contacts

Part #	Description
13010C	4-Way, 8 Point Indent Crimp Tool
13015C	4-Way, 12 Point Indent Crimp Tool

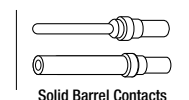

# Punchdown Tools



## **PRO-Strike™**

### **PRO-Strike™ Punchdown Tool**

Combines rugged design, an ergonomic comfort grip handle, and enhanced functions. The primary tool for all telecom and datacom installers working with 110, 66, Krone, and BIX style cross connects. This professional tool will provide precise, repeatable, and reliable terminations that helps ensure installations pass certification and your peace-of-mind.

#### **Features**

- Terminate and cut Cat3/5/5e/6 cables
- Spring loaded for fast, low effort wire seating and termination
- Bayonet style (twist and lock) blade retention socket is compatible with industry standard tools and blades
- New built-in hook – feeds or removes wire
- New multi-use spudger – for screwdriver, IDC insert tool, or to clean debris
- 110, 66, 630, Krone, and BIX style interchangeable blades
- Color coded yellow on the cut side of the tool per industry standard
- Adjustable low and high force impact settings are precisely controlled to meet the industry standard 8762D Spec
- Will not damage sensitive circuitry
- Spare blade storage compartment in the handle

<b>Part #</b>	<b>Description</b>
<b>13150C</b>	<b>PRO-Strike™ Punchdown Tool, Handle Only</b>
<b>13155C</b>	<b>PRO-Strike™ Punchdown Tool, w/NEVERDull™ 66 Blade</b>
<b>13156C</b>	<b>PRO-Strike™ Punchdown Tool, w/NEVERDull™ 110 Blade</b>
<b>13157C</b>	<b>PRO-Strike™ Punchdown Tool, w/NEVERDull™ 66 &amp; 110 Blades</b>
<b>13159C</b>	<b>PRO-Strike™ Punchdown Tool, w/NEVERDull™ 66/110 Combo Blade</b>

***We Make Connections EZ!***

## Punchdown Blades

### Features

- Bayonet style (twist and lock) blades are compatible with all industry standard punchdown tools
- Manufactured from high carbon tool steel
- Heat treated for durability

Part #	Description
13003C	Punchdown Blade, 630 Style
13004C	110 EZ-Data Cut Blade®, w/2 Spare Knives
13004BLC	Replacement Knives (3) for P/N 13004C
13022C	Punchdown Extension Tool
13023C	Punchdown Blade, BIX™ Style
13024C	Punchdown Blade, Krone Style
13031C	Punchdown Blade, NEVERDull™ 66/110 Style
13032C	Punchdown Blade, NEVERDull™ 110 Style
13033C	Punchdown Blade, NEVERDull™ 66 Style



13003C



13023C



13022C



13024C

### 110 EZ-Data Cut Blade®

- Replaceable cutting knives, precision ground from medical grade stainless steel
- Lower cost, replace just the cutting knives, not the entire blade
- Beveled cutting edge
- Faster, cleaner termination
- Less stress on sensitive circuitry

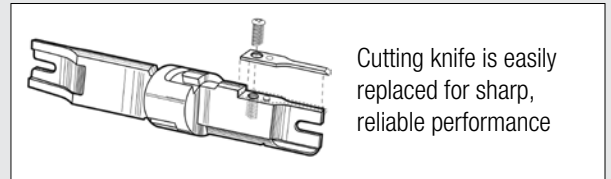

Cutting knife is easily replaced for sharp, reliable performance

### NEVERDull™ Blade

Increase productivity and reduce costs by upgrading to the NEVERDull Blades. These high-performance blades stay sharper longer than traditional ones.

- Advanced MIMS construction (Metal Injection Molding) ensures higher performance and longevity
- Works with all industry standard 110 and 66 style cross connect blocks and keystone jacks



13031C



13032C



13033C

## PT Punchdown Tool

The primary tool for all telecom and datacom installers working with 110, 66, Krone, and BIX style cross connects. This professional tool will provide precise, repeatable, and reliable terminations that will help ensure installations pass certification and your peace-of-mind.

### Features

- Terminate and cut Cat3/5/5e/6 cables
- Spring loaded for fast, low effort wire seating and termination
- Bayonet style (twist and lock) blade retention socket is compatible with industry standard tools and blades
- 110, 66, 630, Krone, and BIX style interchangeable blades
- Built-in hook – feeds or removes wire
- Built-in spudger – for screwdriver, IDC insert tool, or to clean debris
- Adjustable Hi-Lo force impact settings are precisely controlled to meet the industry standard 8762D spec
- Large blade storage compartment



Part #	Description
13300C	Punchdown Tool, handle only
13305C	Punchdown Tool, w/NEVERDull™ 66 Blade
13306C	Punchdown Tool, w/NEVERDull™ 110 Blade
13307C	Punchdown Tool, w/NEVERDull™ 66 & 110 Blade
13309C	Punchdown Tool, w/NEVERDull™ 66/110 Combo Blade

## Non-Impact Tool with 110 EZ-Data Cut Blade®

This economical non-impact tool includes the patented 110 EZ-Data Cut Blade for a new level of performance. It features a precision ground, replaceable cutting knife with a beveled cutting edge for faster, cleaner terminations.

### Features

- Terminates 110-style keystone blocks and jacks
- Lower cost, replace just the cutting knife
- Faster, cleaner terminations



Part #	Description
100111C	Non-Impact Tool with 110 EZ-Data Cut Blade®
13004BLC	Replacement Knives (3)

## PRO Punchdown Kit

Keeps your tools readily accessible and organized so you're always ready to perform those datacom jobs. This tool pouch kit will quickly become part of your daily gear. Kit includes a black, Fine Tip Sharpie® Pen and product instructions.



### 90152C

#### Kit Includes:

- Professional Electrician's Scissors
- PT Punchdown Tool
- 110 Punchdown Blade
- Punchdown Tool Pouch

Part #	Description
90152C	PRO Punchdown Kit



## Xpress Jack™

The Xpress Jack is designed to make keystone jack terminations easier than ever. Seats and trims all 8 conductors in one simple and smooth motion. No more punching down 8 times for a single termination. Saves time and energy on both small and large jobs.

### Features

- One stroke keystone jack terminations
- Heavy duty all carbon tool steel construction
- Designed for 110 type 4 pair keystone jacks
- Rust resistant black oxide finish
- Comfort grip TPR handles. Reduce hand stress on large jobs with prolonged use
- Die set for Platinum Tools Keystone Jacks and other jacks with same design
- Die set available for Leviton Keystone Jacks 90° and other jacks with same design

Part #	Description
13501C	Xpress Jack™ w/Platinum Tools Die
13551C	Platinum Tools Die
13552C	Leviton Die

*See page 52  
for compatible Platinum Tools  
Keystone Jacks*



13501C

**Seats and trims all 8 conductors in one motion.**

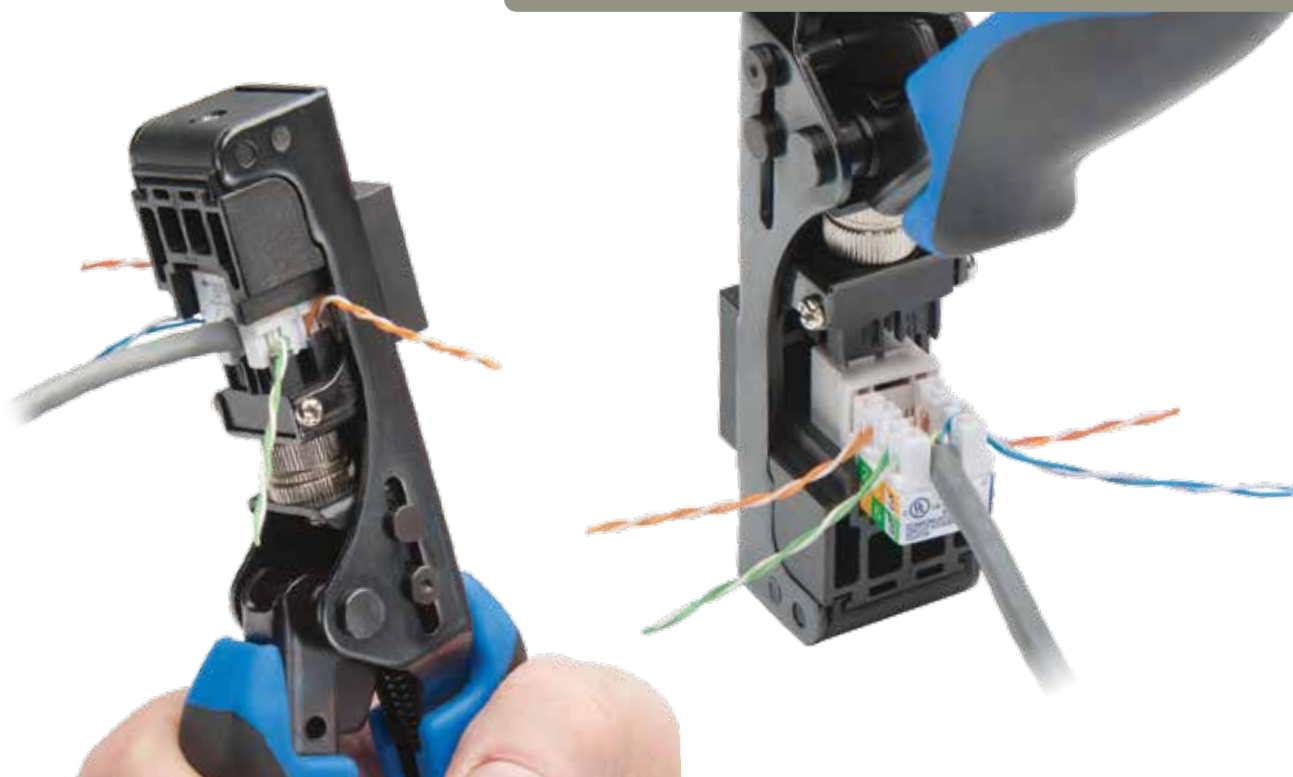

# Specialty Tools

## 7" Long Nose Crimping Pliers

Designed to seat UR/UY/UB style connectors, AMP tel splice connectors, 709 series connectors, and "B" type connectors, as well as act as standard long nose pliers. Drop forged chrome vanadium steel with comfort grip dipped handles.

### Features

- Hardened side-cutting blades
- 0.030" stripping hole for clean, easy wire stripping
- Built in stop which prevents damage to connectors
- Grooved jaws for easy gripping, twisting, and wrapping of wires
- Cleanly strips 23 AWG and 24 AWG wire

Part #	Description
12101C	7" Long Nose Crimping Pliers



## 6" Long Nose Telcom Pliers

Designed with a thin, grooved nose to assist with gripping, twisting, and wrapping wires. Drop forged chrome vanadium steel with comfort grip dipped handles.

### Features

- Hardened side-cutting blades
- 0.030" stripping hole for clean, easy wire stripping
- Grooved jaws for easy gripping, twisting, and wrapping of wires

Part #	Description
12102C	6" Long Nose Telcom Pliers



## 6" Telcom Diagonal Cutting Pliers

Designed with the Telecom technician in mind. Includes stripping holes and hardened cutting jaws for multiple uses. Drop forged chrome vanadium steel with comfort grip dipped handles.

### Features

- 0.030" and 0.045" wire stripping holes
- V-notch grooves built into jaws for quick insulation slitting
- Grooved behind the jaws for crushing of connector insulation
- Tapered nose for easy working in confined areas and close tip cutting

Part #	Description
12103C	6" Telcom Diagonal Cutting Pliers



## 8.5" and 6" Lineman's Pliers

A fresh take on a classic design for gripping, twisting, bending, and cutting wire and cable. The two-tone (TPR) molded comfort grip handle helps make any job a breeze. Features a 6140CrV drop forged body with a hardness level of 45+/-3 and a blade hardness of 58-61 to ensure a clean cut for years to come. The 6" Lineman's Pliers smaller design allows it to fit in places other Lineman's pliers cannot.

### Features

- Body material: 6140CrV
- Body hardness: 45 +/- 3
- Blade hardness: 58 - 61
- Handle material: Black & Red TPR

Part #	Description
12201C	8.5" Lineman's Pliers
12206C	6" Lineman's Pliers



## Connector Pressing Telecom Pliers

Designed to crimp telecom-style splice connectors including UG, UR, UB, and UY style made by 3M and other manufacturers. Manufactured in accordance with Bell Specifications, these pliers feature a built-in side cutter, coil spring, and a built-in stop to prevent damage to connectors.

### Features

- Use for pressing/crimping UR, UY, UG, and UB style connectors
- Also compatible with other telecom-style splice connectors
- Built-in side cutter and stop
- Coil spring
- Vinyl handles

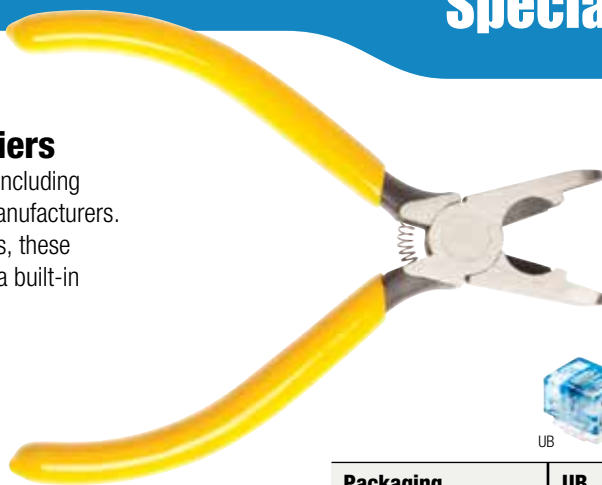

Packaging Description	UB 26-22 AWG	UR 26-19 AWG	UY 26-22 AWG
Clamshell – 25 Pieces	<b>18131</b>	<b>18111</b>	<b>18121</b>
Clamshell – 50 Pieces	<b>18112C</b>		
Clamshell – 100 Pieces	<b>18132C</b>		<b>18122C</b>
Box – 100 Pieces*	<b>18130</b>	<b>18110</b>	<b>18120</b>
Jar – 200 Pieces	<b>28110J</b>		

Part #	Description
<b>12100C</b>	<b>Connector Pressing Telcom Pliers</b>

\* Bulk quantities available. Contact us for pricing & delivery.

## Can Wrench

For telephone craftwork to connect wires to fuses, tighten nuts on binding post terminals, and insert fuses in cable terminals. Double ended 3/8" and 7/16" hex sockets are color coded for quick identification of socket sizes. Design allows use of a wrench for additional torque. Sockets designed with thin walls for access into tight spaces.

### Features

- Fits 3/8" and 7/16" hex nuts
- Access telephone boxes and pedestals
- Tighten nuts on binding post terminals
- Rugged high impact extruded plastic handle
- Manufactured from high carbon tool steel and heat treated for strength and durability



Part #	Description
<b>19059C</b>	<b>Can Wrench</b>

## Heavy Duty Cable Tie Gun

The professional's choice with its robust all steel construction, adjustable tension wheel, and automatic cut-off. Trims cable ties flush, eliminating dangerous sharp edges on cable ties. Use with standard and heavy duty cable ties.

### Features

- Maximum capacity of 0.250" width
- Tension adjustment wheel in handle
- Automatic flush cut-off eliminates sharp edges on ties

Part #	Description
<b>10200C</b>	<b>Heavy Duty Cable Tie Gun</b>

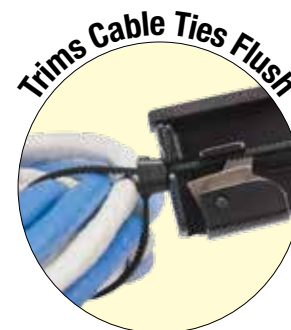

## PRO Drywall Saw

Designed for the demands of professional installers who expect efficiency, ease of use, and accuracy. The teeth are precision ground for fast and effortless cutting in both directions – push and pull. The extra thick blade (1.8mm) prevents bending and breaking during use whether cutting, punching, or scoring.

### Features

- Heavy duty handle designed with a non-slip grip for comfort and safety
- Hardened blade tip designed to score or punch with ease
- One piece handle and blade design
- Ideal for cutting various surfaces, including:
  - Drywall
  - Plywood
  - Plaster board
  - Wallboard
  - Plastic paneling
  - Ceiling tile
- Blade material: High carbon steel SK5
- Rust resistant electrophoretic deposition finish on the blade
- Dimensions: Blade 6 1/4" (160mm)  
Handle 5 1/2" (140mm)

Part #	Description
10711C	PRO Drywall Saw w/Sheath

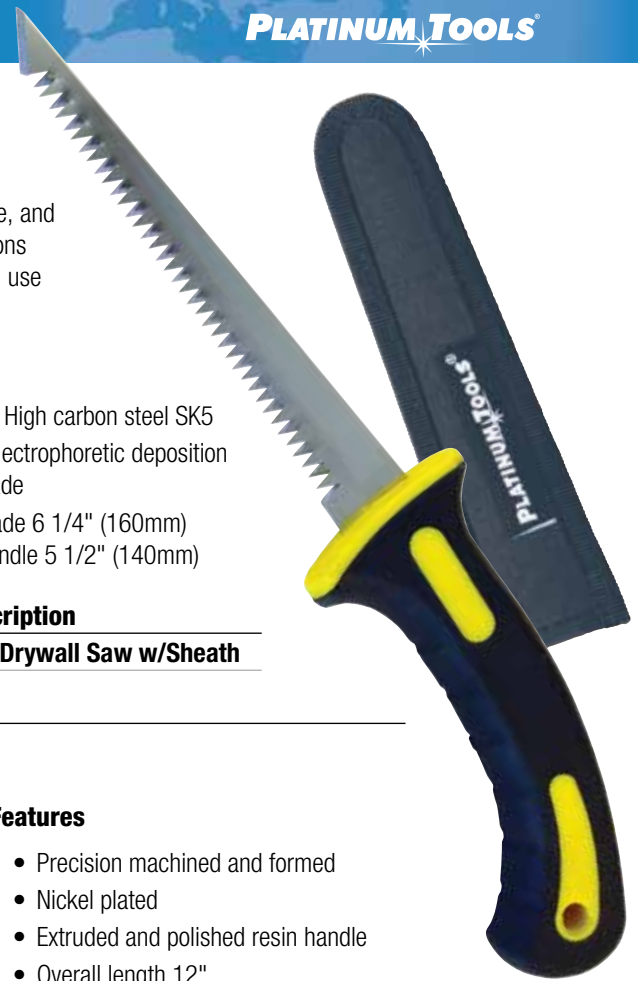

## 1.0/2.3 Connector Removal Tool

Designed to un-mate the push on style 1.0/2.3 Din 75 ohm connector. In high density applications on panels or racks, this tool is a must have for the tool box.

### Features

- Precision machined and formed
- Nickel plated
- Extruded and polished resin handle
- Overall length 12"

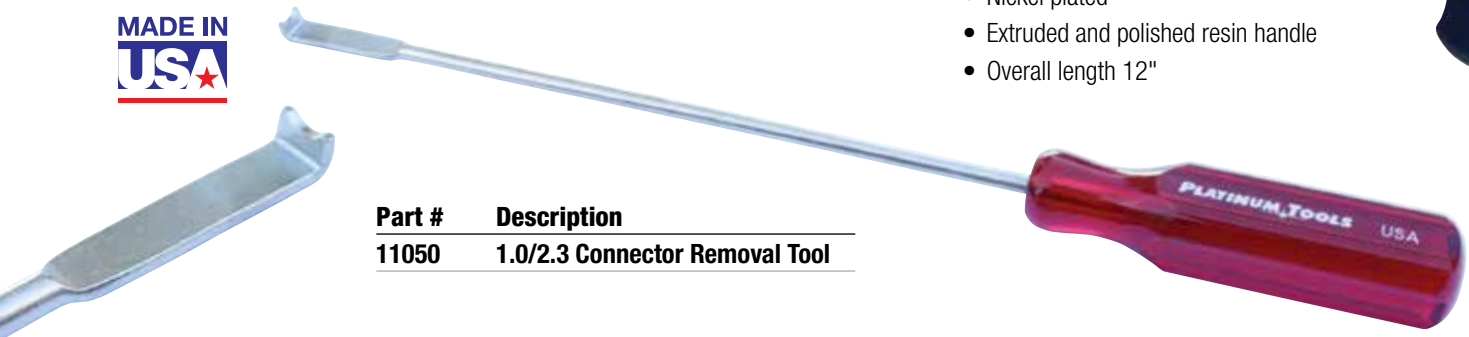

Part #	Description
11050	1.0/2.3 Connector Removal Tool

## BNC Removal Tools

Designed and manufactured for the true broadcast and telecom installation professional. Out-performs all other BNC removal tools in the market today. The barrel is precision machined from high strength tool steel and heat treated for long life. It will not stretch!

### Features

- Use to insert and remove BNC connectors in digital video patch bays and in high-density DSX cross connect systems
- Wider barrel slot fits over Canare L-7CFB and Belden 9292 cables
- Extruded and polished resin handle

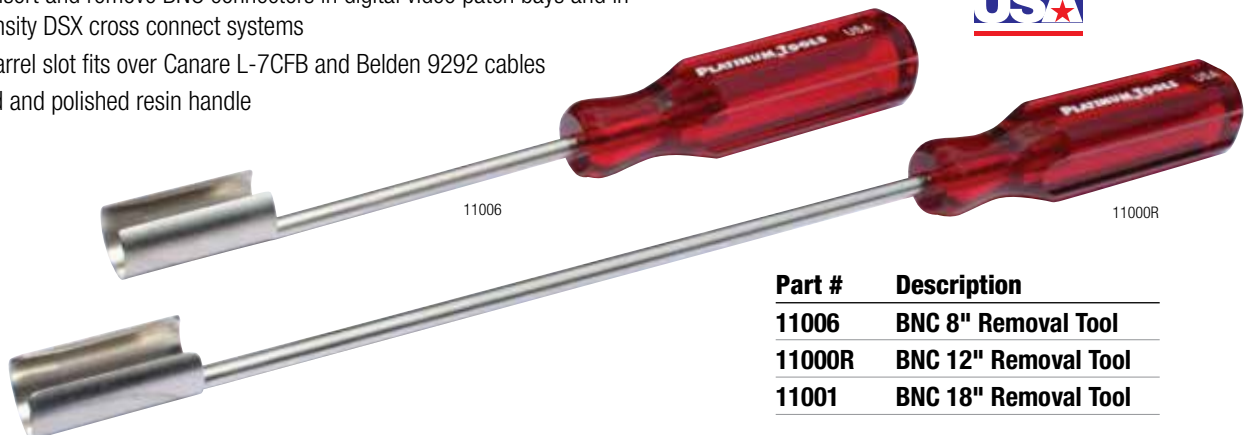

Part #	Description
11006	BNC 8" Removal Tool
11000R	BNC 12" Removal Tool
11001	BNC 18" Removal Tool

## BNC Economy Removal Tools

Manufactured for the professional installer on a budget. Whether working on security, audio, or video installations, the BNC Economy Removal Tools will perform beyond your expectations without compromise.

### Features

- Use to insert and remove BNC connectors in digital video patch bays and in high-density DSX cross connect systems
- Machined from tool steel and heat treated
- Durable handle made from resin

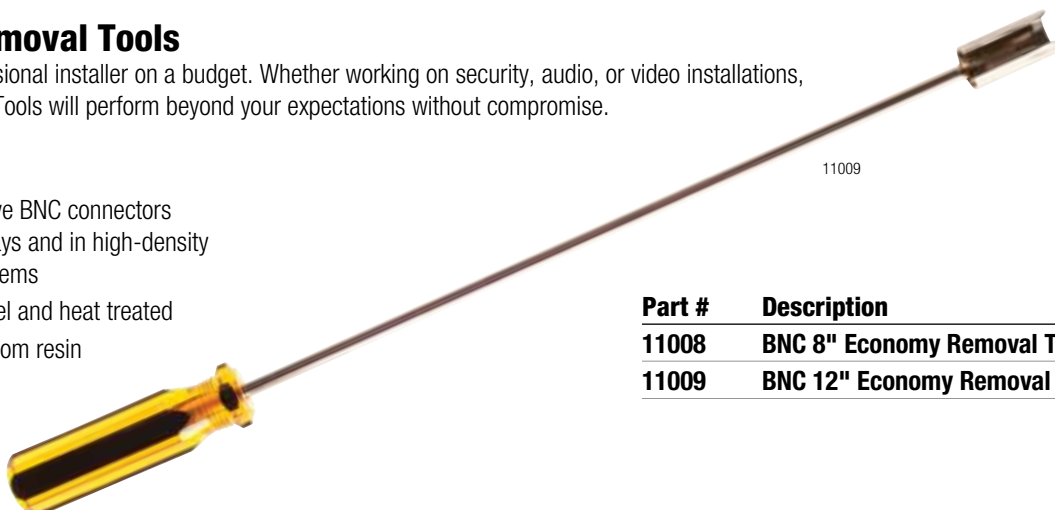

Part #	Description
11008	BNC 8" Economy Removal Tool
11009	BNC 12" Economy Removal Tool

## F Connector Assembly & Removal Tools

These dual function tools feature a 7/16" hex socket at one end and 3/8-32 thread at the other end. The hex socket slides over the cable and rear of the connector for easy mating and un-mating of hard to grasp F connectors. The threaded end provides a stable surface for cable insertion when prepping connectors for termination and can also be used as a thread chaser.

### Features

- 7/16" hex socket for mating and un-mating
- 3/8 – 32 threaded end for connector assembly
- Rugged extruded plastic handle
- Long life chrome finish

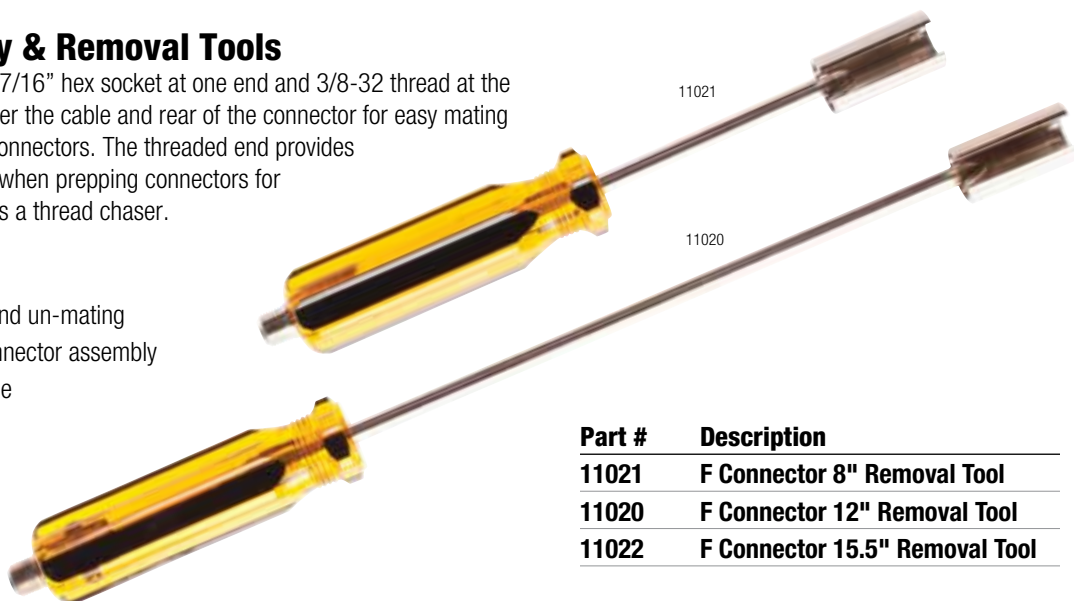

Part #	Description
11021	F Connector 8" Removal Tool
11020	F Connector 12" Removal Tool
11022	F Connector 15.5" Removal Tool

## Security Bit Set, 30 pc

Works on both standard and security screws. Contains all the popular sizes of security and tamper-proof bits for installs of all types. Never be caught without the correct bit for the job.

### 19130C Bit Load

- **Security Torx®:** T8, T9, T10, T15, T20, T25, T30, T40
- **Security Hex:** 3/32", 7/64", 1/8", 9/64", 5/32", 3/16"  
2mm, 2.5mm, 3mm, 4mm, 5.5mm
- **Spanner:** 4, 6, 8, 10
- **Tri-Wings:** 1, 2, 3, 4
- **Torq-Set:** 6, 8, 10

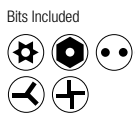

Part #	Description
19130C	Security Bit Set, 30 pc



## PRO 6-in-1 Standard and Security Screwdriver

These ergonomically designed screwdrivers have a high impact plastic core covered in a comfortable cushion grip handle. This feature allows the screwdriver to be used for extended periods of time without hand fatigue or stress. Multiple bit loads included for various applications.

### 19002C Bit Load

- **Phillips:** #1 & #2
- **Slotted:** #5 & #7
- **Nut Drivers:** 1/4" & 5/16"

Bits Included

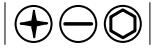

### 19003C Bit Load

- **Security Torx®:** T15, T20, T25, T30
- **Nut Drivers:** 1/4" & 5/16"

Bits Included

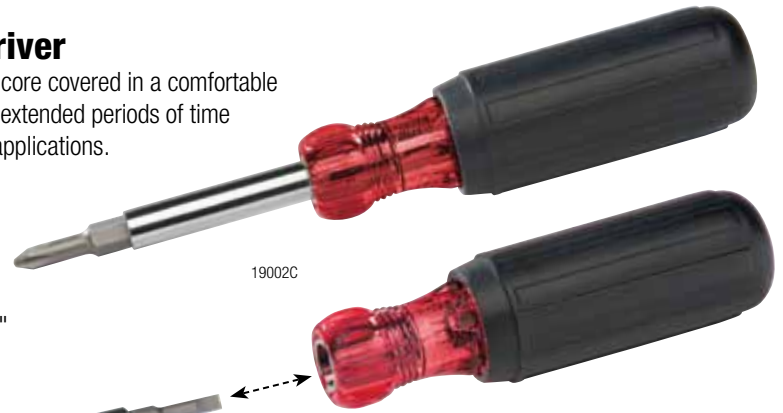

Part #	Description
19002C	PRO 6-in-1 Screwdriver
19003C	PRO 6-in-1 Security Screwdriver

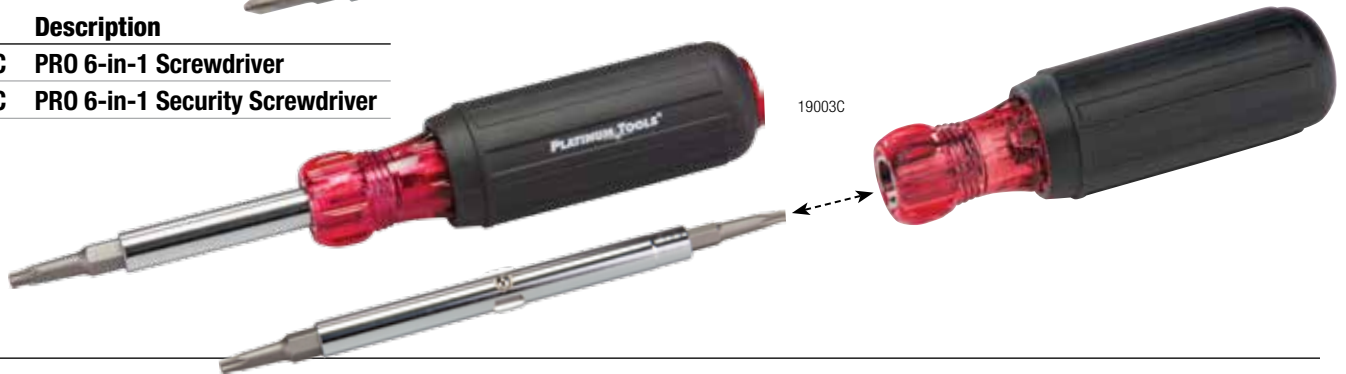

## 6-in-1 Screwdriver

This versatile tool is a must have for any tool belt. Double-ended reversible bits with ball detent retention. S2 alloy steel bits for long life. Molded, ergonomic high impact plastic handle.

### 19001C Bit Load

- **Phillips:** #1 & #2
- **Slotted:** #5 & #7
- **Nut Drivers:** 1/4" & 5/16"

Bits Included



Part #	Description
19001C	6-in-1 Screwdriver



### Tips & Tricks

## Measuring Twisted Pair Cable Length

Maximum cable length per TIA specifications is 328' / 100m, including patch cables! It's impossible to get a true length measurement with a tape measure, so a cable length tester is a must. An accurate cable length tester will ensure that the cable does not exceed the length maximum, so you can be confident that your cable run is wired to spec.



## 22-in-1 Security Screwdriver Kit

The perfect set for security installers – reach into those deep crevices with ease and never be without the right screwdriver. It features a non-slip, comfort grip handle with a high impact plastic core and 11 double sided security shaft style bits. The shaft style enables access into recessed screws up to 5" deep. The bit load includes multiple sizes of Security Torx, Hex, and Robertson along with Spanners and Tri-Wings so the list of applications is endless. This kit can be used on standard hex and torx screws and includes a slotted and Phillips head bit for traditional screwdriver applications.

### 19105 Bit Load

- **Security Torx®:** T8, T10, T15, T20
- **Security Hex:** 1/8", 9/64", 5/32", 3/16"  
2.5mm, 3mm, 4mm, 5.5mm
- **Security Robertson:** 1, 2
- **Spanner:** 4, 6, 8, 10
- **Tri-Wings:** 2, 3
- **Slotted:** 7/32"
- **Phillips:** #2



Part #	Description
19105	22-in-1 Security Screwdriver Kit



## 8-in-1 Ratcheted Stubby Screwdriver

It is the perfect tool for those cramped spaces. Features a six-position bit retention holster in the cap conveniently built directly into the handle. Simply unscrew the top cap and swap bits out as needed, which means no more lost bits! Also features a high force, precision ratcheting mechanism, and a non-slip, TPR rubberized grip for quick tightening and loosening of screws with minimal effort.

### Features

- High force precision ratcheting mechanism
- Forward, reverse, and fixed ratchet
- Hardened chromium-vanadium steel bits and shafts
- 7 bits plus a 1/4" hex nut driver

### 19120C Bit Load

- **Phillips:** #1, #2, #3
- **Slotted:** 3/16", 1/4"
- **Torx®:** T15, T20
- **Nut Driver:** 1/4"



Part #	Description
19120C	8-in-1 Ratcheted Stubby Screwdriver



## Precision Screwdriver 33 Piece Set

Includes tips for Slotted, Phillips, Pozi Drive, and Torx screwdrivers along with hex sockets. The tips are manufactured from high quality, hardened chrome vanadium for long life. The screwdriver handle is molded from TPR for a comfortable, non-slip grip and adjusts from 5" to 9.5" making it perfect for those hard to reach places. Features a smooth action rotating cap and high impact plastic case for convenient storage.

### Features

- Sockets and Shaft: M5 Socket, M6 Socket, M4 Shaft

### 19101 Bit Load

- **Pozi Drive:** PZ1 & PZ0
- **Slotted:** 1.0", 1.5", 2.0", 2.5", 3.0", 3.5", 4.0"
- **Phillips:** #000, #00, #0, #1
- **Torx®:** T4, T5, T6, T7, T8, T9, T10, T15, T20
- **Hex:** 0.7, 0.9, 1.3, 1.5, 2.0, 2.5, 3.0, 4.0

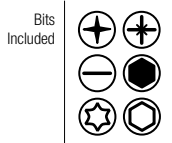

Part #	Description
19101	Precision Screwdriver 33 Piece Set



### Tips & Tricks

## Reshaping the BIG Stuff

### Having trouble inserting cable into your connector?

Use the grip cavity of your pliers and lightly compress the concentricity of your cable, re-shaping it into an oval/rectangular shape. This will make it much easier to insert the cable into the back end of the connector and push it to the correct location as required by termination specs.

Remember, the distance from the point of termination to the twists are:

- Cat5e = less than 1/2"
- Cat6 = less than 3/16"

NOTE: This deformation will not interfere with passing certification.

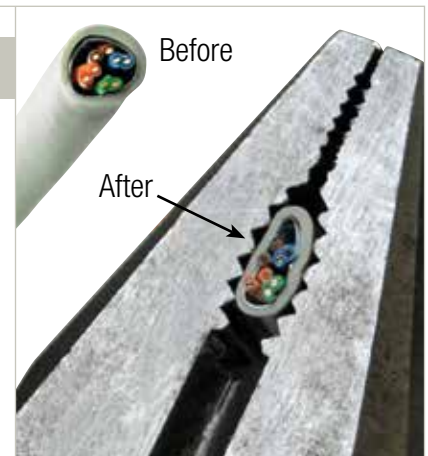



## Micro Mini II 13 Piece Screwdriver Set

Features a combination of the smallest popular bits used in today's electronics. The soft grip TPR handle has a non-magnetic, 4mm bit holder that adjusts from 5" to 8".

### Features

- Hardened (RC55) CrV 8660 Bits
- Smooth action rotating cap
- High impact plastic case

### 19103 Bit Load

- **Slotted:** 2.0", 1.5", 1.2", 1.0"
- **Phillips:** #0000, #000, #00, #0
- **Torx®:** T3, T4, T5, T6



Part #	Description
19103	Micro Mini II 13 Piece Screwdriver Set



## 1 KV Insulated Precision, 6 Piece Screwdriver Set

Convenient set of insulated, precision slotted, and Phillips screwdrivers in a plastic storage/carrying case. The screwdrivers provide shock protection to 1000 VAC and complies with VDE safety standard VDE-400009250.

### Features

- Black oxide tip
- Dual-compound handle

### 19110 Bit Load

- Includes the following sizes:
  - **Slotted:** 0.23 x 1.5 x 65 / 0.4 x 2.0 x 65 / 0.4 x 2.5 x 65
  - **Phillips:** PH00 x 65 / PH0 x 65 / PH1 x 65



Part #	Description
19110	1 KV Insulated Precision, 6 Piece Screwdriver Set



# Connectors

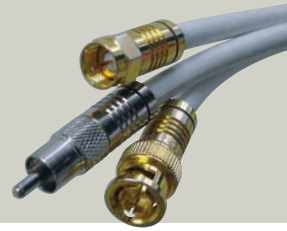

## SealSmart™ Coax Compression “F” Connectors

Cable/Connector Color Code

- Red ● RG59
- Black ● RG6
- Blue ● RG6Q
- Navy ● Mini



### SealSmart II Compression Crimp Tool

Easily terminate F, RCA, and BNC compression style connectors without changing adapters.



See pages 22 & 23  
for additional compression crimp tools

### RG6Q



Packaging Description	Gold Plated	Nickel Plated	Right Angle Nickel Plated
Bag – 100 Pieces	18004	18001	
Bag – 25 Pieces			18001RA
Jar – 75 Pieces		28001J	
Clamshell – 10 Pieces	18005	18002	
Clamshell – 3 Pieces			18003

### RG6



Packaging Description	Gold Plated	Nickel Plated	Right Angle Nickel Plated
Bag – 100 Pieces	18009	18006	
Bag – 25 Pieces			18006RA
Jar – 75 Pieces		28006J	
Clamshell – 10 Pieces	18010	18007	
Clamshell – 3 Pieces			18008

### RG59



Packaging Description	Gold Plated	Nickel Plated	Right Angle Nickel Plated
Bag – 100 Pieces	18015	18011	
Bag – 25 Pieces			18011RA
Jar – 75 Pieces		28011J	
Clamshell – 10 Pieces	18016	18012	
Clamshell – 3 Pieces			18013

### RGB 25 AWG



Packaging Description	Gold Plated	Nickel Plated
Bag – 25 Pieces	18225	18220

### RGB 24 AWG



Packaging Description	Gold Plated	Nickel Plated
Bag – 25 Pieces	18205	18200

### RGB 23 AWG



Packaging Description	Gold Plated	Nickel Plated
Bag – 25 Pieces	18215	18210

### RG11



Packaging Description	Nickel Plated
Bag – 25 Pieces	18311
Clamshell – 4 Pieces	18312

## SealSmart™ Coax Compression “BNC” Connectors

### RG6Q



Packaging Description	Gold Plated	Nickel Plated	Right Angle Nickel Plated
Bag – 25 Pieces	<b>18020</b>	<b>18035</b>	<b>18035RA</b>
Clamshell – 6 Pieces	<b>18021</b>	<b>18036</b>	
Clamshell – 3 Pieces			<b>18037</b>



Cable/Connector Color Code	
Red	● RG59
Black	● RG6
Blue	● RG6Q
Navy	● Mini

### RG6



Packaging Description	Gold Plated	Nickel Plated	Right Angle Nickel Plated
Bag – 25 Pieces	<b>18025</b>	<b>18038</b>	<b>18038RA</b>
Jar – 40 Pieces		<b>28038J</b>	
Clamshell – 6 Pieces	<b>18026</b>	<b>18039</b>	
Clamshell – 3 Pieces			<b>18040</b>

### RG59



Packaging Description	Gold Plated	Nickel Plated	Right Angle Nickel Plated
Bag – 25 Pieces	<b>18030</b>	<b>18041</b>	<b>18041RA</b>
Jar – 40 Pieces		<b>28041J</b>	
Clamshell – 6 Pieces	<b>18031</b>	<b>18042</b>	
Clamshell – 3 Pieces			<b>18043</b>

### RGB 25 AWG



Packaging Description	Gold Plated	Nickel Plated
Bag – 25 Pieces	<b>18255</b>	<b>18250</b>

### RGB 24 AWG



Packaging Description	Gold Plated	Nickel Plated
Bag – 25 Pieces	<b>18235</b>	<b>18230</b>

### RGB 23 AWG



Packaging Description	Gold Plated	Nickel Plated
Bag – 25 Pieces	<b>18245</b>	<b>18240</b>

### Tips & Tricks



## Combing Your Braid

Tired of pulling the braid back over your coax cable jacket and getting little pieces of braid in your fingers?



### Do it the EZ way!

Cut a small piece of Velcro, the ‘prickly’ side, and stick it on the side of your coax stripper. You now have a comb to brush back the braid over the jacket. You will be happy with how nice and even the braid looks and your fingers will be happy too!

## SealSmart™ Coax Compression “RCA” Connectors

### RG6Q



Packaging Description	Gold Plated	Nickel Plated	Right Angle Nickel Plated
Bag – 25 Pieces	18057	18065	18065RA
Clamshell – 6 Pieces	18058	18066	
Clamshell – 3 Pieces			18067



Cable/Connector Color Code	
Red	● RG59
Black	● RG6
Blue	● RG6Q
Navy	● Mini

### RG6



Packaging Description	Gold Plated	Nickel Plated	Right Angle Nickel Plated
Bag – 25 Pieces	18052	18051	18051RA
Jar – 50 Pieces		28051J	
Clamshell – 6 Pieces	18053	18051C	
Clamshell – 3 Pieces			18054

### Tips & Tricks



## Listen To Your Stripper

When stripping coax, do not turn your tool around as though it were a propeller.

### RG59



Packaging Description	Gold Plated	Nickel Plated	Right Angle Nickel Plated
Bag – 25 Pieces	18055	18060	18060RA
Jar – 50 Pieces		28060J	
Clamshell – 6 Pieces	18056	18061	
Clamshell – 3 Pieces			18062

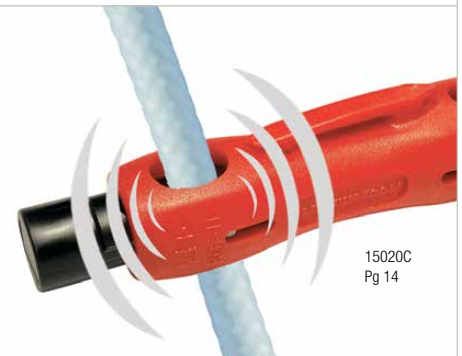

15020C  
Pg 14

### RGB 25 AWG



Packaging Description	Gold Plated	Nickel Plated
Bag – 25 Pieces	18285	18280

### RGB 24 AWG



Packaging Description	Gold Plated	Nickel Plated
Bag – 25 Pieces	18265	18260

### RGB 23 AWG



Packaging Description	Gold Plated	Nickel Plated
Bag – 25 Pieces	18275	18270

As you rotate your tool, listen to the cutting of the braid and when it stops talking to you, turn another 1/8 to a 1/4 turn, open tool and remove the stripper. When rotating, be sure the hand that is holding the cable is supporting the cable immediately next to the tool. Allow no cable play!

## Coax Adapters

<b>F Connector Coupler, High Performance F81</b> Clamshell – 2 pieces TAD001	
<b>F Connector Coupler F81</b> Clamshell – 2 pieces Bag – 25 pieces 18301C 18301	
<b>BNC Female-to-F Female</b> Clamshell – 2 pieces Bag – 25 pieces 18303C 18303	
<b>BNC Female-to-F Male</b> Clamshell – 2 pieces Bag – 25 pieces 18305C 18305	
<b>F Male-to-F Male Splice</b> Clamshell – 2 pieces Bag – 25 pieces 18307C 18307	

<b>BNC Inline Splice Female-to-Female</b> Clamshell – 2 pieces Bag – 25 pieces 18308C 18308	
<b>F Male Terminator 75 ohm</b> Clamshell – 2 pieces Clamshell – 10 pieces Bag – 25 pieces 18306C 18309C 18309	
<b>BNC Male-to-F Female</b> Clamshell – 2 pieces Bag – 25 pieces 18310C 18310	
<b>RCA Male-to-BNC Female</b> Clamshell – 2 pieces Bag – 25 pieces 18314C 18314	

## Telecom Splicing Connectors

Utilize an insulation displacement contact (IDC) design for fast, simple, reliable terminations. No wire stripping is required and connectors will accept wire of different gauges. All connectors are gel filled to provide moisture resistance and inhibit corrosion. For use with solid copper conductors only. Typical uses include butt splicing 2 or 3 wires of the same or different gauges. Perfect for pigtail and load coil splice applications.

### Features

#### Telecom Splicing Connectors UB-Gel Filled

- 26-22 AWG, in-line tap
- Tap directly on to existing wire without interrupting service
- Max insulation OD, 0.050" (1.27mm)

#### Telecom Splicing Connectors UR-Gel Filled

- 26-19 AWG, 2 or 3 wire splice
- Use for butt splicing 2 or 3 wires
- Wires can be of different wire gauges
- Max. insulation OD, 0.066"(1.67mm)

#### Telecom Splicing Connectors UY-Gel Filled

- 26-22 AWG, 2 wire splice
- Wires can be of different wire gauges
- Max. insulation OD, 0.060" (1.52mm)



Packaging Description	UB 26-22 AWG	UR 26-19 AWG	UY 26-22 AWG
Clamshell – 25 Pieces	<b>18131</b>	<b>18111</b>	<b>18121</b>
Clamshell – 50 Pieces		<b>18112C</b>	
Clamshell – 100 Pieces	<b>18132C</b>		<b>18122C</b>
Box – 100 Pieces*	<b>18130</b>	<b>18110</b>	<b>18120</b>
Jar – 200 Pieces		<b>28110J</b>	

\* Bulk quantities available.  
Contact us for pricing & delivery.

## Cat6A Flex Connectors – Shielded & Non-Shielded

The Cat6A Flex Connector makes Cat6A and Cat7 terminations easier than ever. The unique patented design ensures top tier performance for Cat6A and Cat7 cabling. These connectors provide a low cost, easy termination solution with high performance and superior connectivity options.

### Features

- Tool-less termination design
- Minimal tools required for preparation
- Accommodates Cat6A and Cat7 cables up to 9.0mm and 26-22 AWG Conductors
- Works with both solid and stranded conductors
- Machine-precision-set contact height
- Frequency rated up to 1 GHz
- 10 Gigabit certified
- PoE+ rated
- Flexible design:
  - Can flex 90° down
  - Can flex 45° up
  - Allows the cable to hang vertically, eliminating bend and the need for strain reliefs

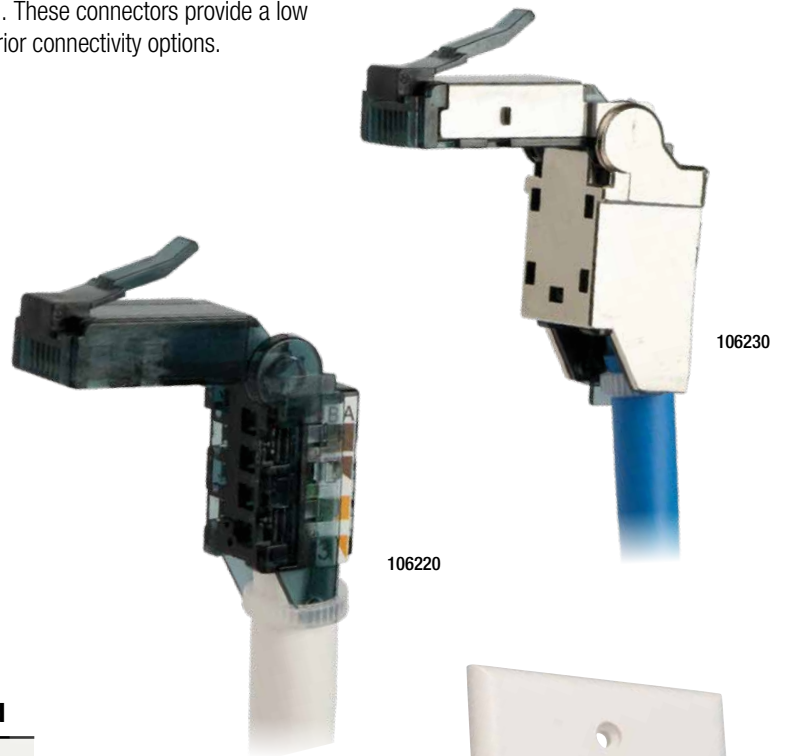

### Cat6A Flex Connectors

Packaging Description	Non-Shielded	Shielded
Bag – 1 Piece	106220	106230



*90° Flex so cables hang vertically!*

*No Crimp Tool Required!*

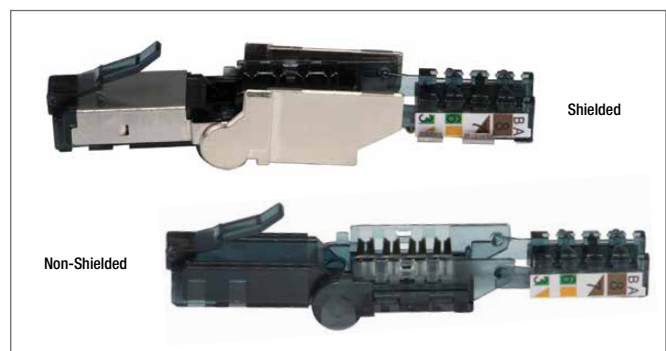

## ezEX- RJ45® Connectors – Designed for Cat5e/6/6A Cables

This RJ45 connector is a single connector solution for Cat5e/6/6A cables. Features a unique integrated Hi-Lo stagger load bar that allows 'big' conductors to pass through the front end of the connector making it easy to verify the wiring sequence before terminating.

**The ezEX™44 connector is typically used with Cat5e/6 cable and the ezEX™48 with Cat6A.**

### Features

- Hi-Lo stagger to isolate each conductor
- Simple one piece/pass through design, no bars or liners
- Cat5e/Cat6/Cat6A compliant
- Insulation Diameter (Conductor)  
Size range:  
- ezEX44 = 0.039" – 0.044" (1.0–1.12mm)  
- ezEX48 = 0.043" – 0.048" (1.09–1.22mm)
- Solid or Stranded 24-22 AWG
- RoHS 2, UL, and FCC compliant



### ezEX-RJ45 Connectors

Packaging Description	ezEX44	ezEX48
Clamshell – 10 Pieces	100018C	100019C
Clamshell – 50 Pieces	100028C	100029C
Jar – 100 Pieces	202044J	202048J
Bag – 500 Pieces	105024	105025

Note: Max Outer Diameter: 0.290" (7.36mm)

ezEX-RJ45  
Internal Ground



ezEX-RJ45  
External Ground

### ezEX-RJ45 Shielded Connectors

Packaging Description	ezEX44 Internal Ground	ezEX44 External Ground	ezEX48 External Ground
Clamshell – 25 Pieces	100024C	100025C	100027C
Jar – 50 Pieces	202050J	202051J	202052J
Bag – 100 Pieces	105027	105028	105029

Note: Max Outer Diameter: 0.305" (7.75mm)

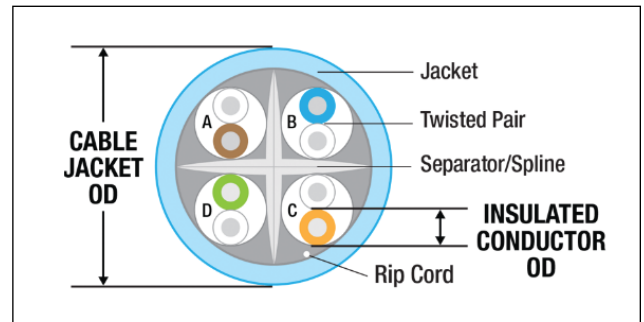
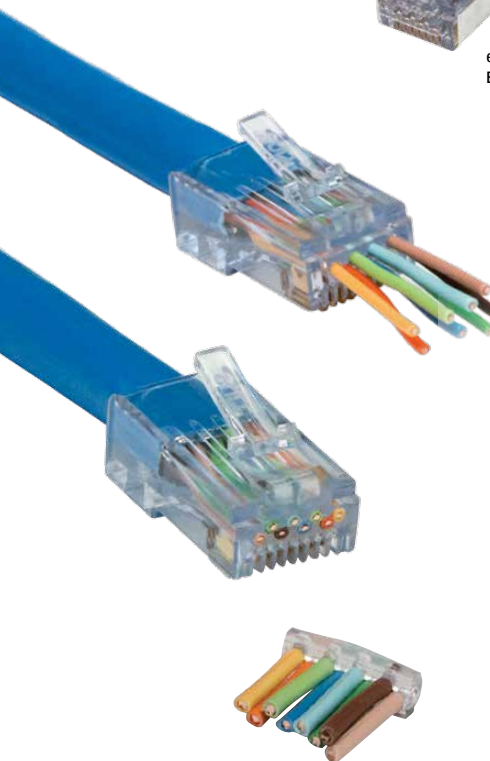

Wires protrude from the front of the connector before being trimmed flush.



Front of connector after termination and wires are trimmed flush.

### EXO Crimp Frame with EXO-EX Die P/N 100061C

This is the tool you need to crimp and trim ezEX RJ45 connectors.

See page 17 for more information about the EXO Crimp Tool.



## EZ Connectors... "The World's Easiest Twisted Pair Termination System"

The revolutionary design of the EZ Connectors transformed the way modular plugs are prepped and crimped. By allowing each individual conductor to completely pass through the connector and out of the front terminations are greatly simplified. Installers can easily see and verify the proper wiring order before crimping. The unique design also optimizes electrical performance by reducing the distance between the wire twists and contacts. Whether terminating data or voice connections, the job is EZ using the EZ-RJ45 crimp tools – crimp and trim the wires in one easy cycle.

### Features

- Through holes allow pairs to pass through the front of the connector for faster terminations
- EZ to verify wiring sequence
- More reliable and higher performance
- Works with solid or stranded wire – separate connectors are not required reducing inventory and preventing confusion
- Reduces scrap by eliminating wasted crimps
- Simple one-piece design – bars or liners are not required
- Use in Cat3, Cat5, Cat5e, or Cat6 compliant voice and data networks
- FCC and RoHS compliant
- UL rated
- Manufactured in the USA
- Patented design

## Terminating Connectors is as EZ as 1-2-3!

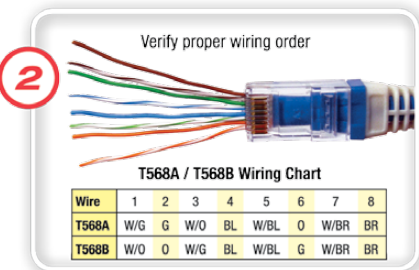
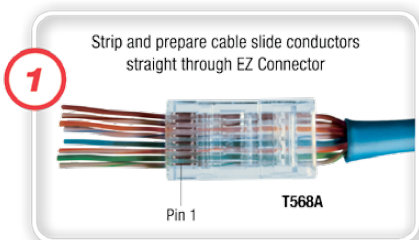

### Front end of EZ Connector

Through holes allow wire pairs to be inserted through front of connector for faster terminations.



## EZ-RJ12/11™ Connectors

### EZ-RJ12/11 Standard Tab



#### Packaging Description

Clamshell – 50 Pieces	100026C
Box – 100 Pieces	100026B
Jar – 100 Pieces	202026J
Bag – 500 Pieces	105005

### EZ-RJ12/11 Long Tab



#### Packaging Description

Clamshell – 50 Pieces	100026LTC
Box – 100 Pieces	100026LTB
Bag – 500 Pieces	105005LT

## EZ-RJ45® Connectors

### EZ-RJ45 Cat5e



#### Packaging Description

Clamshell – 15 Pieces	100015
Clamshell – 50 Pieces	100003C
Box – 100 Pieces	100003B
Jar – 100 Pieces	202003J
Bag – 500 Pieces	105003

### EZ-RJ45 Cat6



#### Packaging Description

Clamshell – 10 Pieces	100009C
Clamshell – 50 Pieces	100010C
Box – 100 Pieces	100010B
Jar – 100 Pieces	202010J
Bag – 500 Pieces	105004



## EZ-RJ45® Shielded Cat5e/6 Connector with Internal or External Ground

Combines the performance advantage exclusive to the EZ-RJ45 design with the performance advantage inherent to shielded products to provide an unparalleled solution for the market. In applications where NEXT, FEXT, and AXT are an issue, using shielded products can be the solution. This connector is designed to work on both Cat5e and Cat6 cables, solid or stranded.

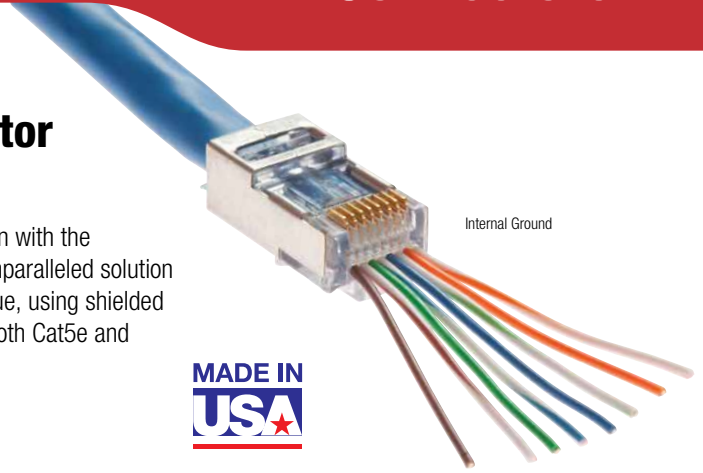

### Internal Ground

Packaging Description	
Clamshell – 10 Pieces	<b>100021C</b>
Clamshell – 50 Pieces	<b>100020C</b>
Bag – 50 Pieces	<b>100020</b>
Jar – 50 Pieces	<b>202020J</b>
Bag – 100 Pieces	<b>105020</b>

Max cable OD: 0.260"

Max conductor OD: 0.041"

### External Ground

Packaging Description	
Clamshell – 10 Pieces	<b>100023C</b>
Clamshell – 50 Pieces	<b>100022C</b>
Bag – 50 Pieces	<b>100022</b>
Jar – 50 Pieces	<b>202022J</b>
Bag – 100 Pieces	<b>105022</b>

Max cable OD: 0.280+"

Max conductor OD: 0.041"

### Features

- FCC compliant
- UL and RoHS compliant
- 50 micro inch gold plate
- Patented



## 50/50 Combo Jars

100 Piece Jar of 50 EZ-RJ45 Connectors and 50 EZ Strain Reliefs



Packaging Description	
Jar – EZ-RJ45® Cat5e 50/50 Combo	<b>202015J</b>
Jar – EZ-RJ45® Cat6 50/50 Combo	<b>202016J</b>

## 30/30 Cat6 Combo Pack

60 Piece Clamshell of 30 Cat6 EZ-RJ45 Connectors and 30 Color Coded Strain Reliefs



Packaging Description	
Clamshell – EZ-RJ45® Cat6 30/30 Combo (10 each Red/Blue/Grey Strain Reliefs)	<b>100011C</b>

## Snag Proof EZ Strain Reliefs

Designed specifically for crimping with the EZ-RJ45 Connectors, the primary strain relief of the plug locks the snag proof strain relief in place creating an integrated assembly; it will not pull off. Achieve the look of a commercially molded patch cord with a field termination and most importantly eliminate snags or hang ups. Patents pending.

### Features

- Prolong patch cord life
- Maintain bend radiuses required for standards compliance
- Optimizes electrical performance
- No more snags or hang ups, causing tangled messes
- Easier to unlock the connector when unplugging from jack/port
- UL and RoHS compliant



Packaging Description	Cat5e	Cat6
Jar – 100 Pieces	<b>202035J</b>	<b>202036J</b>
Clamshell – 50 Pieces	<b>100035C</b>	<b>100036C</b>
Bag – 50 Pieces	<b>100035</b>	<b>100036</b>
Bag – 500 Pieces	<b>105015</b>	<b>105016</b>

Note: Max Outer Diameter: 0.260" (6.60mm)

## Standard Modular Plugs

### Standard Modular Plugs

Traditional crimp WE/SS-style modular plugs for use in terminating cables in both telephone and data applications.

#### Features

- Multiple position and contact configuration styles available
- Round and flat cable versions
- 2 prong stranded conductor contact
- 3 prong solid conductor contact
- Gold plated contacts provide reliable performance and long life
- Complies with FCC 68 guideline
- UL listed
- Flammability Rating: UL94V-2
- Materials: Polycarbonate
- Contact material: Phosphor bronze
- Plating: 50µ & 15µ gold

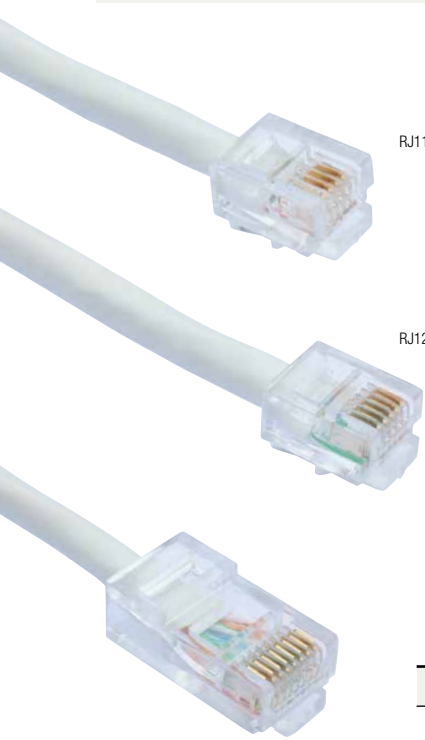

RJ11

RJ12

RJ45 - Standard

### RJ11/12 – Round, Stranded



Packaging Description	RJ11 (6P4C)	RJ12 (6P6C)
Clamshell – 25 Pieces	106117C	106132C
Jar – 100 Pieces	106118J	106133J
Bag – 500 Pieces	106115	106130

### RJ11/12 – Round, Solid



Packaging Description	RJ11 (6P4C)	RJ12 (6P6C)
Clamshell – 25 Pieces	106122C	106137C
Jar – 100 Pieces	106123J	106138J
Bag – 500 Pieces	106120	106135

### RJ22/11/12 – Flat, Stranded



Packaging Description	RJ22 (4P4C)	RJ11 (6P4C)	RJ12 (6P6C)
Clamshell – 25 Pieces	106102C	106112C	106127C
Jar – 100 Pieces	106103J	106113J	106128J
Bag – 500 Pieces	106100	106110	106125

### Cat5e RJ45 – 8P8C



Packaging Description	Flat, Stranded 2 prong conductor contact	Round, Stranded 2 prong conductor contact	Round, Solid 3 prong conductor contact
Clamshell – 25 Pieces	106142C	106147C	106152C
Jar – 100 Pieces	106143J	106148J	106153J
Bag – 500 Pieces	106140	106145	106150

### Cat5e RJ45 – 8P8C

Hi-Lo Stagger One Piece Design: 50µ

Packaging Description	Round, Stranded 2 prong conductor contact	Round, Solid 3 prong conductor contact
Clamshell – 25 Pieces	106162C	106167C
Jar – 100 Pieces	106163J	106168J
Bag – 500 Pieces	106160	106165



Packaging Description	Round, Solid, Shielded 3 prong conductor contact
Bag – 100	106180
Clamshell – 50	106182C
Clamshell – 10	106183C

## Standard Modular Plugs

### Cat6 RJ45 – 8P8C

Non-Shielded



**Two Piece Design: 50µ**



**Round, Solid, Non-Shielded**

3 prong conductor contact, w/Liner

**Packaging Description**

Clamshell – 25 Pieces	<b>106187C</b>
Jar – 100 Pieces	<b>106188J</b>
Bag – 500 Pieces	<b>106185</b>

**Round, Solid, Shielded**

3 prong conductor contact, w/Liner



Shielded

RJ45 - High Performance

Clamshell – 10 Pieces	<b>106208C</b>
Clamshell – 50 Pieces	<b>106207C</b>
Jar – 100 Pieces	<b>106206J</b>
Tray – 100 Pieces	<b>106205</b>

Max cable OD: 0.285" or 7.24mm | Max conductor OD: 0.044" or 1.12mm | 23-24 AWG

### Cat6 RJ45 – 8P8C

**Three Piece Design: 50µ**



**Round, Stranded**

2 prong conductor contact

**Round, Solid**

3 prong conductor contact

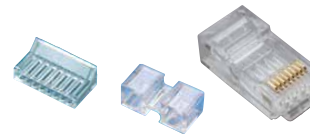

**Packaging Description**

Clamshell – 25 Pieces	<b>106172C</b>	<b>106177C</b>
Jar – 100 Pieces	<b>106173J</b>	<b>106178J</b>
Bag – 500 Pieces	<b>106170</b>	<b>106175</b>

Max cable OD: 0.270" or 6.85mm | Max conductor OD: 0.040" or 1.01mm | 24 AWG

## RJ45 Cat6A 10Gig Shielded Connectors with Liners

Platinum's 10Gig System was developed to support today's 10Gig infrastructure. In environments where speed transmission, uptime, and response are critical, companies are using 10Gig. It delivers the necessary bandwidth and also builds for future emerging technologies. Our system addresses the challenges of working with larger cables like Cat6E, Cat6A, and Cat7. Our connectors deliver the performance needed to stream large data, audio, and video files. Coupled with the Tele-TitanXg or the Tele-TitanXg 2.0, you can rest assured your installation exceeds industry standard performance.

**Features**

- Exceeds 10Gig performance standard
- UL and RoHS compliant
- Max cable OD: 0.335" (8.5mm)
- Max conductor OD: 0.053" (1.35mm)

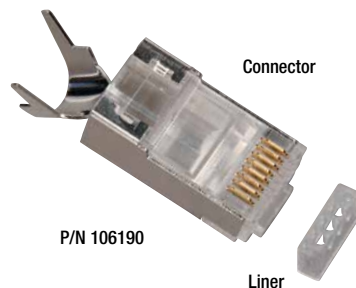

P/N 106190

Connector

Liner

See pages 90-91 for 10Gig Termination Kit

### RJ45 Cat6A 10Gig Connectors

Packaging Description	Solid	Stranded
Clamshell – 10 Pieces	<b>106193C</b>	<b>106198C</b>
Clamshell – 50 Pieces	<b>106192C</b>	<b>106197C</b>
Bag – 25 Pieces	<b>106191</b>	
Bag – 50 Pieces	<b>106192</b>	<b>106197</b>
Bag – 100 Pieces	<b>106190</b>	<b>106195</b>

**Spare Liners**

Bag – 50 Pieces	<b>106194</b>
-----------------	---------------

## RJ45 Boots

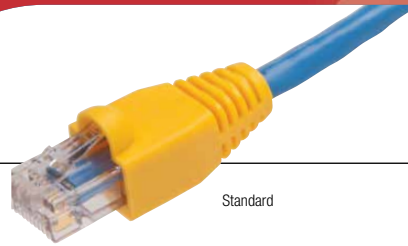

Standard

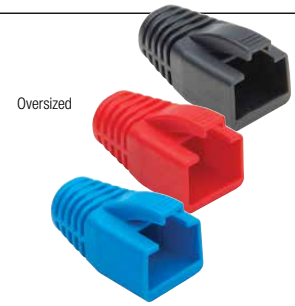

Oversized

Organize your cables and protect RJ45 plugs with snagless Cat5e and Cat6 boots.

### Features

- Protect the connector
- Prevent tangled messes
- Eliminate broken release/locking tabs
- Relieve stress on cable
- Help maintain radius bend
- Color code designated
- Cover the external ground on shielded connectors
- Manufactured from PVC material

Color	Quantity	Standard Cable OD Ranges			
		5.5mm OD (0.217")	6mm OD (0.236")	6.5mm OD (0.260")	7mm OD (0.275")
Red	100/bag	105060	105071	105081	105091
	25/bag	100031R-BG	100032R-BG	100033R-BG	100034R-BG
Blue	100/bag	105061	105072	105082	105092
	25/bag	100031B-BG	100032B-BG	100033B-BG	100034B-BG
Black	100/bag	105062	105073	105083	105093
	25/bag	100031BK-BG	100032BK-BG	100033BK-BG	100034BK-BG
Grey	100/bag	105063	105074	105084	105094
	25/bag	100031GY-BG	100032GY-BG	100033GY-BG	100034GY-BG
Green	100/bag	105064	105075	105085	105095
	25/bag	100031GR-BG	100032GR-BG	100033GR-BG	100034GR-BG
Yellow	100/bag	105065	105076	105086	105096
	25/bag	100031Y-BG	100032Y-BG	100033Y-BG	100034Y-BG
White	100/bag	105066	105077	105087	105097
	25/bag	100031W-BG	100032W-BG	100033W-BG	100034W-BG
Purple	100/bag	105067	105078	105088	105098
	25/bag	100031P-BG	100032P-BG	100033P-BG	100034P-BG
Orange	100/bag	105068	105079	105089	105099
	25/bag	100031O-BG	100032O-BG	100033O-BG	100034O-BG

Oversized Cable OD Ranges		
7.5mm OD (0.295")	8mm OD (0.315")	8.5mm OD (0.335")
105102	105105	105108
100037R-BG	100038R-BG	100039R-BG
105100	105103	105106
100037B-BG	100038B-BG	100039B-BG
105101	105104	105107
100037BK-BG	100038BK-BG	100039BK-BG

## Color Coded Strain Reliefs



Packaging Description	Red	Blue	Grey	Green	Yellow	Black
Clamshell – 50 Pieces	100030R-C	100030B-C	100030GY-C	100030GR-C	100030Y-C	100030BK-C
Bag – 500 Pieces	105006	105007	105008	105009	105010	105011

Compatible with all Standard Modular RJ45 Plugs (page 48) and EZ-RJ45 Cat6 Connectors (page 46).  
 NOTE: Not compatible with the EZ-RJ45 Cat5e Connectors.

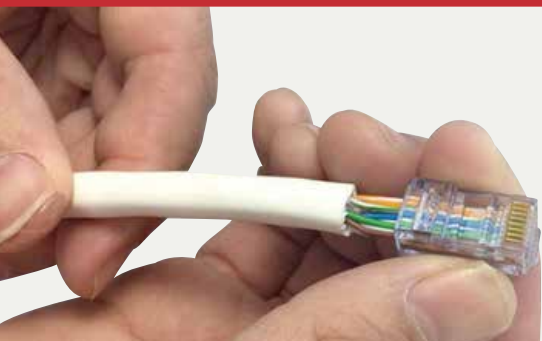

## Why Doesn't This Connector Fit My Cable?

### Something is not right with the connectors

It's the little things that you have to look out for when you're doing a big project. When you get your spool of Cat6 cable and your bags of connectors, prep a cable end and prepare to terminate it with a connector, you expect to finish the job easily, right? But then you find that the cable outer jacket doesn't fit in the connector, and you can't crimp it. Or the conductors are too big, packing in too tightly on the way to the contact punch-downs. You know this isn't right, but you didn't do anything wrong – did you?

### Simple, right?

Cat6 cable, Cat6 connectors. It should be simple. But cable changes are making it hard to terminate with existing Cat6 RJ45 connectors. It's a common problem, and the reason is simple. Cat6 cable can vary and is built to meet performance standards. It can have thicker insulation, larger conductors, tighter twisted pairs and a variety of shielding and grounding arrangements. No wonder the connectors don't simply fit! If you want to do it right and certify your installation, there's a better way.

### A new connector design to match evolving cable

The Platinum Tools ezEX-RJ45 Connectors simplify connector termination and also adapts to a wider variety of outer diameters, insulation sizes, and conductor diameters. This new ezEX-RJ45 Connectors are the easiest RJ45 connector to terminate larger cables in the industry.

### What's in your connector bin?

Platinum Tools reworked the trusty RJ45 in clever ways to make room for growing cable outer diameters and insulation (conductor) diameters. We also engineered two versions of the connector to provide the right size for your specific cable parameters. It's time to take the generic connectors out of your bins, and set up to meet the advanced specs of the new cable you're using. The connectors work with a one-shot tool system (EXO Crimp Frame) that is like a cable factory – it holds the connector and wires in place and crimps, chops, and is done.

## The Connector Selector Guide

If you're currently looking for the correct connector for the cable you're installing we have a great new tool for this: Platinum Tools Connector Selector Guide will ask you a few questions (Cable Jacket OD, Insulated Conductor OD, Shielded or Unshielded, Solid or Stranded) on the cable terminating and then displays the connectors that will fit your cable. This new tool will make selecting connectors much easier.

**SELECTOR GUIDE**

CLICK IMAGE TO ENLARGE

Use the sliders or type your required diameters in the boxes\*

**CABLE JACKET OD**

Inches

mm

**INSULATED CONDUCTOR OD**

Inches

mm

SHIELDED

NON-SHIELDED

SOLID

STRANDED

Try it today! Visit:  
[www.platinumtools.com/connector-selector/](http://www.platinumtools.com/connector-selector/)

# Structured Wiring

## Keystone Jacks and Couplers

Platinum Tools is known as a leader in providing products and solutions for the structured wiring networking world of data, voice, and video. Keystone Jacks, Wall Plates, and EZ-SnapJacks are the latest additions to our growing line of solutions.

### Features

- Color coded to make EIA/TIA 568A/B wiring easy
- Contacts 50 micron gold
- Meets/Exceeds EIA/TIA Category Standards
- Compatible with industry standard wall plates
- RoHS Compliant and UL Listed

Cat3, Cat5e, Cat6, and Cat6A

## Keystone Jacks – Installer Packs of 50

Part #	Description
723LA-50	Keystone Cat3, 6 Pin, 110 Jack, Light Almond
723WH-50	Keystone Cat3, 6 Pin, 110 Jack, White
725BL-50	Keystone Cat5e, 110 Jack, Blue
725LA-50	Keystone Cat5e, 110 Jack, Light Almond
725WH-50	Keystone Cat5e, 110 Jack, White
726BL-50	Keystone Cat6, 110 Jack, Blue
726LA-50	Keystone Cat6, 110 Jack, Light Almond
726WH-50	Keystone Cat6, 110 Jack, White
752BL-1	Keystone Cat6A, Tool-less, UTP Jack, Blue (1)
752WH-1	Keystone Cat6A, Tool-less, UTP Jack, White (1)
780LA-50	Keystone F - 3GHz, Light Almond
780WH-50	Keystone F - 3GHz, White

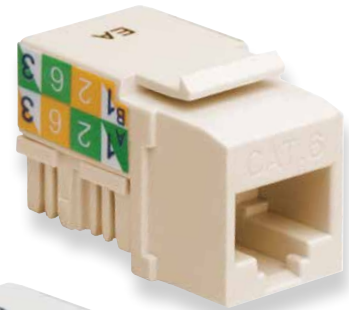

726LA-50



726WH-50

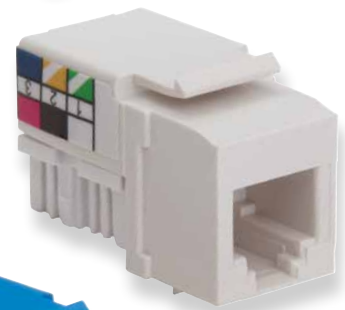

723WH-50



725BL-50

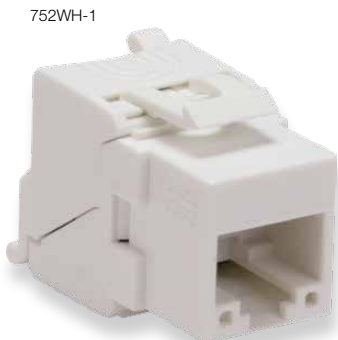

752WH-1

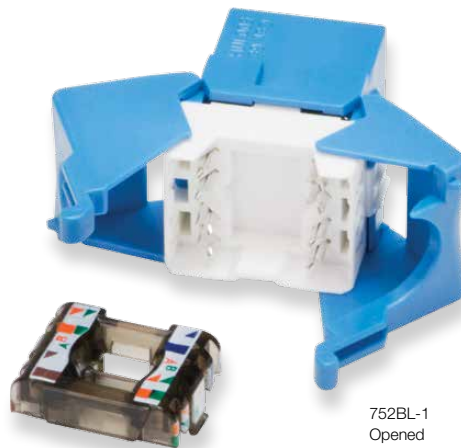

752BL-1  
Opened

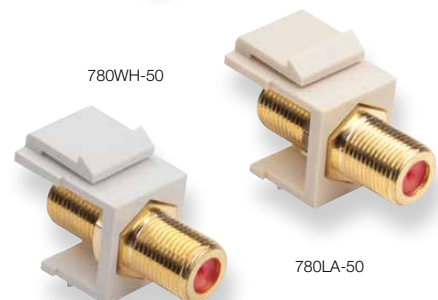

780WH-50

780LA-50

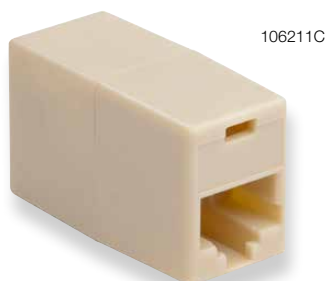
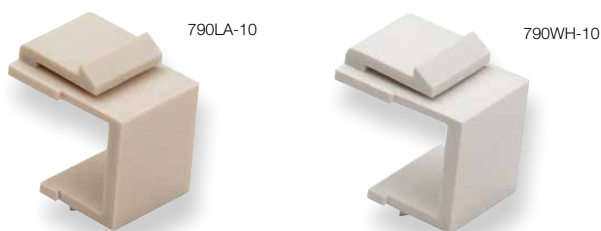

## Keystone Coupler – Installer Bags (10 Pcs./Bag)

Part #	Description
765WH-10	Keystone Cat5e Data Coupler, White

## In-Line Coupler – 2 Per Clamshell

Part #	Description
106211C	RJ45 In-Line Coupler, Light Almond

## Keystone Blank Inserts – Installer Bags (10 Pcs./Bag)

Part #	Description
790LA-10	Keystone Blank Insert, Light Almond
790WH-10	Keystone Blank Insert, White

## 10Gig Keystone Jacks – Shielded 1 Per Clamshell

Part #	Description
751-1	Keystone Cat6A, Tool-less, Shielded, Jack

## Keystone HDMI – 1 Per Clamshell

Part #	Description
775WH-1C	HDMI to HDMI Pigtail, White



## Wall Plates

A simple solution for connecting and managing your data, audio, video, and telephone connectivity and networks. Compatible with most industry standard keystone jacks like Leviton, ICC, and others.

### Features

- Compatible with most industry standard keystone jacks and EZ-SnapJacks
- Engineered to prevent possible fracturing from over tightened screws
- Drillable material
- UL and RoHS compliant
- One-piece, single-gang, 4 1/2" X 2 3/4"
- Includes color matching mounting screws
- Designed to fit standard single-gang outlet boxes

## Wall Plates – Installer Packs of 25

Part #	Description
600WH-25	Standard 1 Gang Blank, White
601LA-25	Standard 1 Port, Light Almond
601WH-25	Standard 1 Port, White
602LA-25	Standard 2 Port, Light Almond
602WH-25	Standard 2 Port, White
604LA-25	Standard 4 Port, Light Almond
604WH-25	Standard 4 Port, White



600WH-25



601WH-25



601LA-25



604WH-25



602WH-25

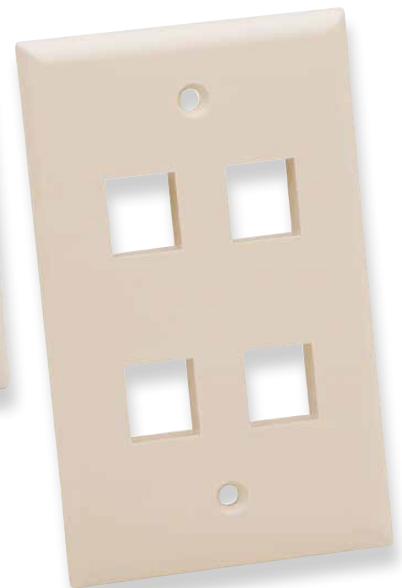

604LA-25



## EZ-SnapJack™

You may never need a punchdown tool – at least for your wall jacks – again. The patented EZ-SnapJack is self-terminating and quickly installs for professional results in a snap. Available for both Cat5e and Cat6 cable types.

### Features

- FCC, UL, ULC, and RoHS compliant
- 50 micro-inch selective gold plating
- Molded from UL94-VO material
- Meets/exceeds TIA/EIA-568B.2-1
- Save time – no need for eight punchdowns
- Repair damaged jacks on the spot
- Wire guide ensures pairs stay in proper order for fast, easy termination
- Designed to fit industry standard wallplates in seven colors
- Optimal for new or retrofits in commercial and home automation installations
- EZ-SnapJacks are re-useable
- Reduced tool cost, no PDT required

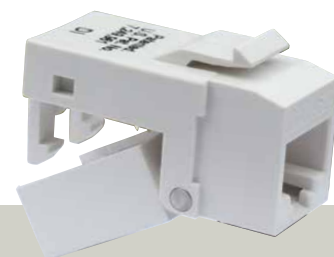

### Prep cable

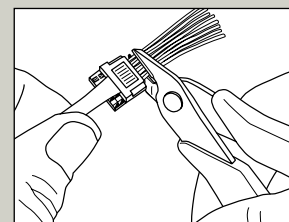
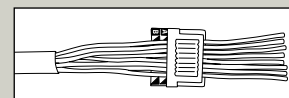

### Insert wire guide

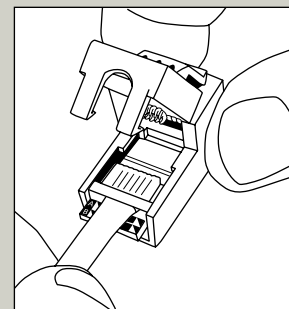

### Snap together

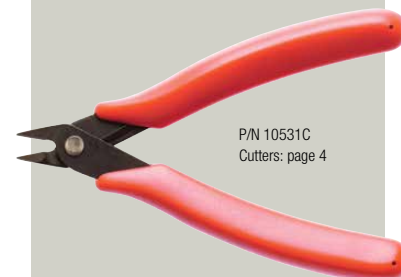
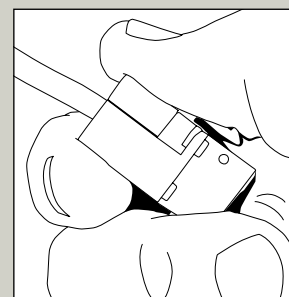

P/N 10531C  
Cutters: page 4

### EZ-SnapJack – Cat5e

Color	Clamshell 4 Pcs	Bulk Bag 1 Pc./Bag	Installer Pack 40 Pieces	Jar 20 Pcs
White 	705WH-4C	705WH-1	705WH-40	705WH-20J
Light Almond 	705LA-4C	705LA-1	705LA-40	
Blue 	705BL-4C	705BL-1	705BL-40	705BL-20J
Ivory 	705IV-4C	705IV-1	705IV-40	
Black 	705BK-4C	705BK-1	705BK-40	
Yellow 	705YL-4C	705YL-1	705YL-40	
Orange 	705OR-4C	705OR-1	705OR-40	

### EZ-SnapJack – Cat6

Clamshell 4 Pcs	Bulk Bag 1 Pc./Bag	Installer Pack 40 Pieces
706WH-4C	706WH-1	706WH-40
706LA-4C	706LA-1	706LA-40
706BL-4C	706BL-1	706BL-40
706IV-4C	706IV-1	706IV-40
706BK-4C	706BK-1	706BK-40
706YL-4C	706YL-1	706YL-40
706OR-4C	706OR-1	706OR-40

## Patch Panels

An efficient and convenient solution to terminating all the cable runs coming in from various rooms to one main location commonly referred to as the server room or wiring closet.

### Cat5e, Cat6, and Cat6A

#### Patch Panels – Cat5e, Cat6, and Cat6A

Part #	Description
650-12C5	12 Port Cat5e Non-Shielded
660-12C6	12 Port Cat6 Non-Shielded
667-12C6S	12 Port Cat6 Shielded
651-24C5	24 Port Cat5e Non-Shielded
661-24C6	24 Port Cat6 Non-Shielded
668-24C6S	24 Port Cat6 Shielded
675-24C6AS	24 Port Cat6A Shielded

**Patch Panels** are key to connecting and routing circuits in your network and beneficial to:

- Keeping your cables tidy
- Making it easier to identify your cables
- Keep your cables secure
- Easier to re-configure and troubleshoot your network

### 12 Port Cat6 Shielded Patch Panel

Wall Mount

#### Features

- High strength frame for rigidity and durability. Eliminates flexing and warping
- Cable management bracket, helps support/eliminate cable disconnects (integrated)
- Removable shielded dust cover
- Locking screw terminals for cable support and security, eliminates disconnects
- Wall Mount
- Meets ANSI/EIA/TIA 568C.2 Standard
- Color coded label for easy wiring T568A & B
- 110/Krone punchdown compatible
- Solid or stranded 22 thru 26 AWG wire
- Ideal for voice, data, video, and audio applications
- Gold plated RJ45 port contacts
- RoHS Compliant and UL Listed



See page 50  
for RJ45 Boots



## 12 Port Cat5e Non-Shielded Patch Panel

Wall Mount, Vertical Design

P/N 650-12C5



Front



Back

## 12 Port Cat6 Non-Shielded Patch Panel

Wall Mount, Vertical Design

P/N 660-12C6



Front



Back

### Features

#### 12 Port Cat5e and Cat6 Non-Shielded

- Wall Mount / Vertical Design
- 110/Krone punchdown compatible
- Meets ANSI/EIA/TIA 568C.2 Standard
- Color coded label for easy wiring T568A & B
- Solid or stranded 22-26 AWG wire
- ABS Plastic Housing
- Gold plated RJ45 port contacts
- Ideal for voice, data, video, and audio applications
- RoHS Compliant and UL Listed

## 24 Port Cat5e Non-Shielded Patch Panel

1U spacing  
P/N 651-24C5



Front

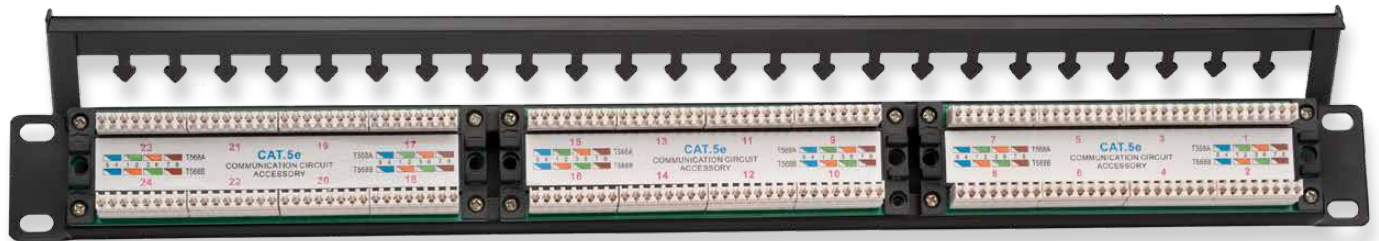

Back

## 24 Port Cat6 Non-Shielded Patch Panel

1U spacing  
P/N 661-24C6



Front



Back

### Features

#### 24 Port Cat5e and Cat6 Non-Shielded Patch Panels

- 1U spacing, traditional 19-inch rack design
- Cable management bracket, helps support/eliminate cable disconnects (removable)
- High strength frame for rigidity and durability, eliminates flexing and warping
- Color coded label for easy wiring T568A & B
- Meets ANSI/EIA/TIA 568C.2 Standard
- 110/Krone punchdown compatible
- Solid or stranded 22-26 AWG wire
- Ideal for voice, data, video, and audio applications
- Gold plated RJ45 port contacts
- RoHS Compliant and UL Listed

## 24 Port Cat6 Shielded Patch Panel

1U spacing  
P/N 668-24C6S

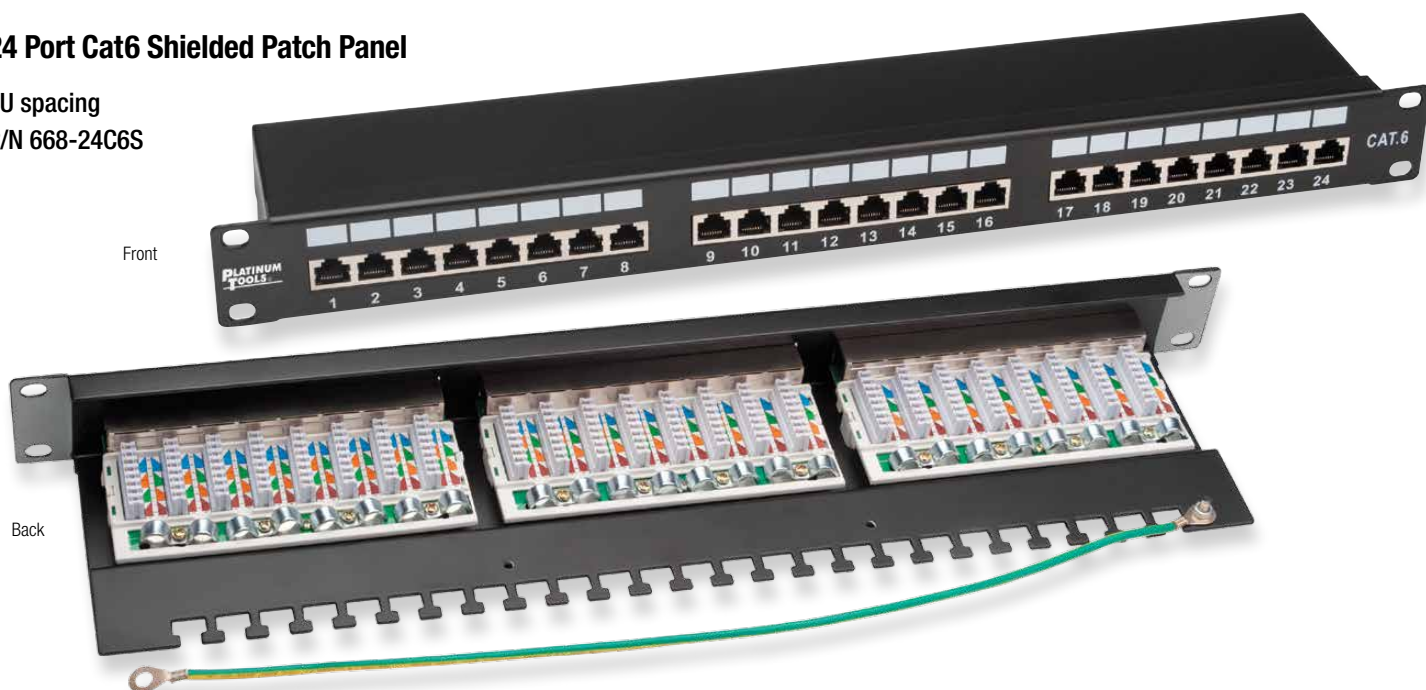

## 24 Port Cat6A Shielded Patch Panel

1U spacing  
P/N 675-24C6AS

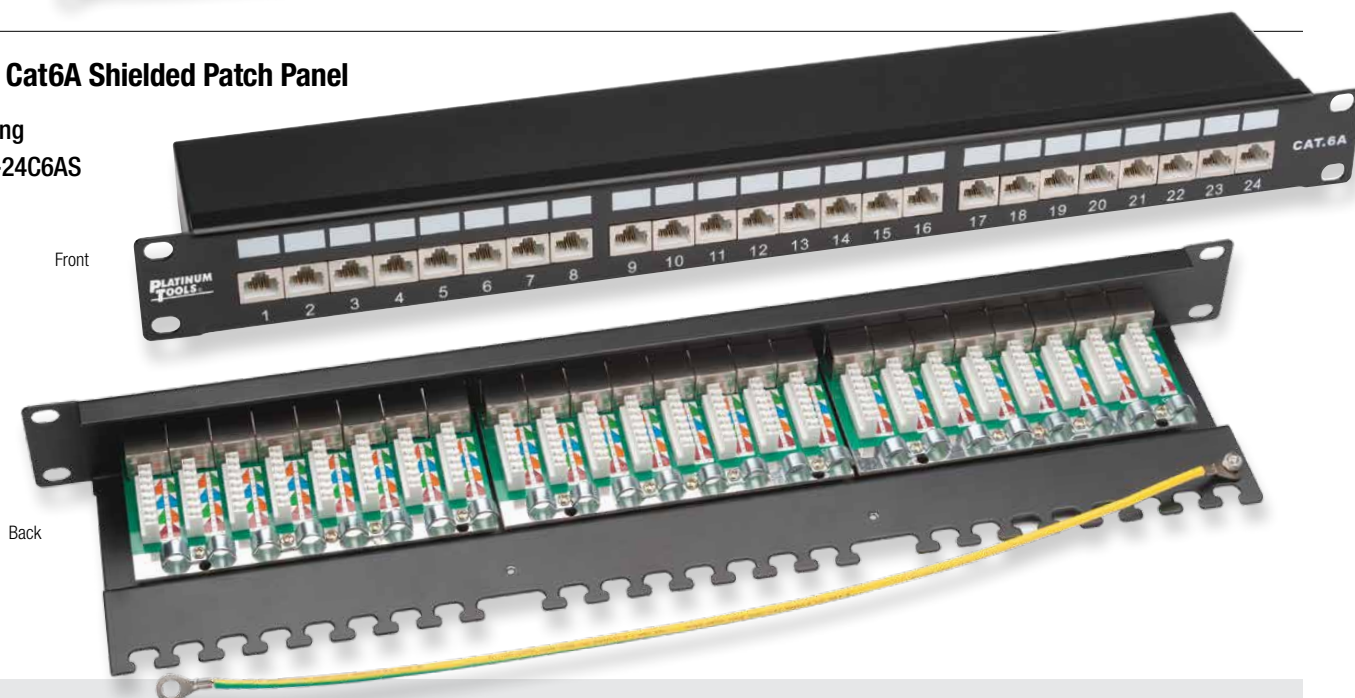

### Features

#### 24 Port Cat6 and Cat6A Shielded Patch Panels

- 1U spacing, traditional 19-inch rack design
- High strength frame for rigidity and durability. Eliminates flexing and warping
- Cable management bracket, helps support/eliminate cable disconnects (integrated)
- Removable shielded dust cover
- Locking screw terminals for cable support and security, eliminates disconnects
- Meets ANSI/EIA/TIA 568C.2 Standard
- Color coded label for easy wiring T568A & B
- 110/Krone punchdown compatible
- Solid or stranded 22-26 AWG wire
- Ideal for voice, data, video, and audio applications
- Gold plated RJ45 port contacts
- RoHS Compliant and UL Listed

# Cable Management

## HPH High Performance J-Hooks



	Cable Capacity			Standard HPH	90° HPH	Batwing HPH
	Cat5e	Cat6	Cat6A			
1" Size 16	20	15	10	<b>HPH16-25</b> 25/ Box	<b>HPH16AC-25</b> 25/ Box	<b>HPH16W-25</b> 25/ Box
2" Size 32	90	60	35	<b>HPH32-25</b> 25/ Box	<b>HPH32AC-25</b> 25/ Box	<b>HPH32W-25</b> 25/ Box
3" Size 48	200	150	80	<b>HPH48-25</b> 25/ Box	<b>HPH48AC-25</b> 25/ Box	<b>HPH48W-25</b> 25/ Box
4" Size 64	330	220	140	<b>HPH64-25</b> 25/ Box	<b>HPH64AC-25</b> 25/ Box	<b>HPH64W-25</b> 25/ Box

**HPH J-Hook Load Capacity:** Ultimate static load is 50 lbs for each size

### HPH High Performance J-Hooks

#### Features

- Wide base cable support (2") provides optimal bend radius for high performance data cables: Cat6, Cat6A, and Cat7
- Built-in reusable "Snap-lock" Retainer, firmly secures cables
- Made with an easy slide, slick, burr free surface
- cULus listed
- Complies with UL 2043
- Plenum Rated
- RoHS compliant
- TIA Compliant
- Light weight
- Eco-Friendly Finish
- Flush mount
- UV resistant
- Economical



Eliminates the use of Cable Ties/Velcro Ties



Snap-lock Closed

Snap-lock Open



HPH32 J-Hook with JH932 Hardware Accessory



See Pages 62-63 for HPH J-Hook Hardware Accessories

## Standard Multi-Purpose J-Hooks



	Cable Capacity		Standard	90° Standard	Batwing Standard
	Cat5e	Cat6			
3/4" Size 12	16	10	<b>JH12-25</b> 25/ Box	<b>JH12AC-25</b> 25/ Box	<b>JH12W-25</b> 25/ Box
3/4" Size 12	16	10	<b>JH12-100</b> 100 / Box	<b>JH12AC-100</b> 100 / Box	<b>JH12W-100</b> 100 / Box
1 5/16" Size 21	50	32	<b>JH21-25</b> 25/ Box	<b>JH21AC-25</b> 25/ Box	<b>JH21W-25</b> 25/ Box
1 5/16" Size 21	50	32	<b>JH21-100</b> 100 / Box	<b>JH21AC-100</b> 100 / Box	<b>JH21W-100</b> 100 / Box
2" Size 32	80	50	<b>JH32-25</b> 25/ Box	<b>JH32AC-25</b> 25/ Box	<b>JH32W-25</b> 25/ Box
2" Size 32	80	50	<b>JH32-100</b> 100 / Box	<b>JH32AC-100</b> 100 / Box	<b>JH32W-100</b> 100 / Box
4" Size 64	300	185	<b>JH64-25</b> 25/ Box	<b>JH64AC-25</b> 25/ Box	<b>JH64W-25</b> 25/ Box

## Standard Multi-Purpose J-Hooks

### Features

- Traditional style, construction grade
- Stress free cable support to organize and build a distribution pathway for various types of cables
- The perfect solution for heavy duty hanging applications
- Use above suspended ceilings, or below raised floors
- Pre-assembled with rivet
- All steel construction
- UL and CUL listed
- Material: Galvanized Steel
- Finish: Yellow Zinc Chromate

### Standard J-Hook Load Capacity:

Standard Size	Load (lbs.)	Standard Size	Load (lbs.)
12 (3/4")	12	32 (2")	17
21 (1 5/16")	17	64 (4")	50

	Cable Capacity		Hammer-On, Swivels 360°	Hammer-On	Beam Clamp, Swivels 360°	Spring Steel Beam Clamp, Swivels 360°
	Cat5e	Cat6				
3/4" Size 12	16	10	<b>JH12ACFM24-100</b> for flanges 1/8"-1/4", 100/Box	<b>JH12HOK24-100</b> for flanges 1/8"-1/4", 100/Box	<b>JH12BC-100</b> (Beam Clamp) for flanges 1/8"-1/2", 100/Box	
3/4" Size 12	16	10	<b>JH12ACFM58-100</b> for flanges 5/16"-1/2", 100/Box	<b>JH12HOK58-100</b> for flanges 5/16"-1/2", 100/Box	<b>JH12ACSSBC-100</b> (Spring Steel Beam Clamp) for flanges 1/8"-1/2", 100/Box	
1 5/16" Size 21	50	32	<b>JH21ACFM24-100</b> for flanges 1/8"-1/4", 100/Box	<b>JH21HOK24-100</b> for flanges 1/8"-1/4", 100/Box	<b>JH21BC-100</b> (Beam Clamp) for flanges 1/8"-1/2", 100/Box	
1 5/16" Size 21	50	32	<b>JH21ACFM58-100</b> for flanges 5/16"-1/2", 100/Box	<b>JH21HOK58-100</b> for flanges 5/16"-1/2", 100/Box	<b>JH21ACSSBC-100</b> (Spring Steel Beam Clamp) for flanges 1/8"-1/2", 100/Box	
2" Size 32	80	50	<b>JH32ACFM24-100</b> for flanges 1/8"-1/4", 100/Box	<b>JH32HOK24-100</b> for flanges 1/8"-1/4", 100/Box	<b>JH32BC-100</b> (Beam Clamp) for flanges 1/8"-1/2", 100/Box	
2" Size 32	80	50	<b>JH32ACFM58-100</b> for flanges 5/16"-1/2", 100/Box	<b>JH32HOK58-100</b> for flanges 5/16"-1/2", 100/Box	<b>JH32ACSSBC-100</b> (Spring Steel Beam Clamp) for flanges 1/8"-1/2", 100/Box	
4" Size 64	300	185	<b>JH64ACFM24-25</b> for flanges 1/8"-1/4", 25/Box	<b>JH64HOK24-25</b> for flanges 1/8"-1/4", 25/Box	<b>JH64BC-25</b> (Beam Clamp) for flanges 1/8"-1/2", 25/Box	
4" Size 64	300	185	<b>JH64ACFM58-25</b> for for flanges 5/16"-1/2", 25/Box	<b>JH64HOK58-25</b> for flanges 5/16"-1/2", 25/Box	<b>JH64ACSSBC-25</b> (Spring Steel Beam Clamp) for flanges 1/8"-1/2", 25/Box	

## J-Hook Hardware Accessories – Accessories

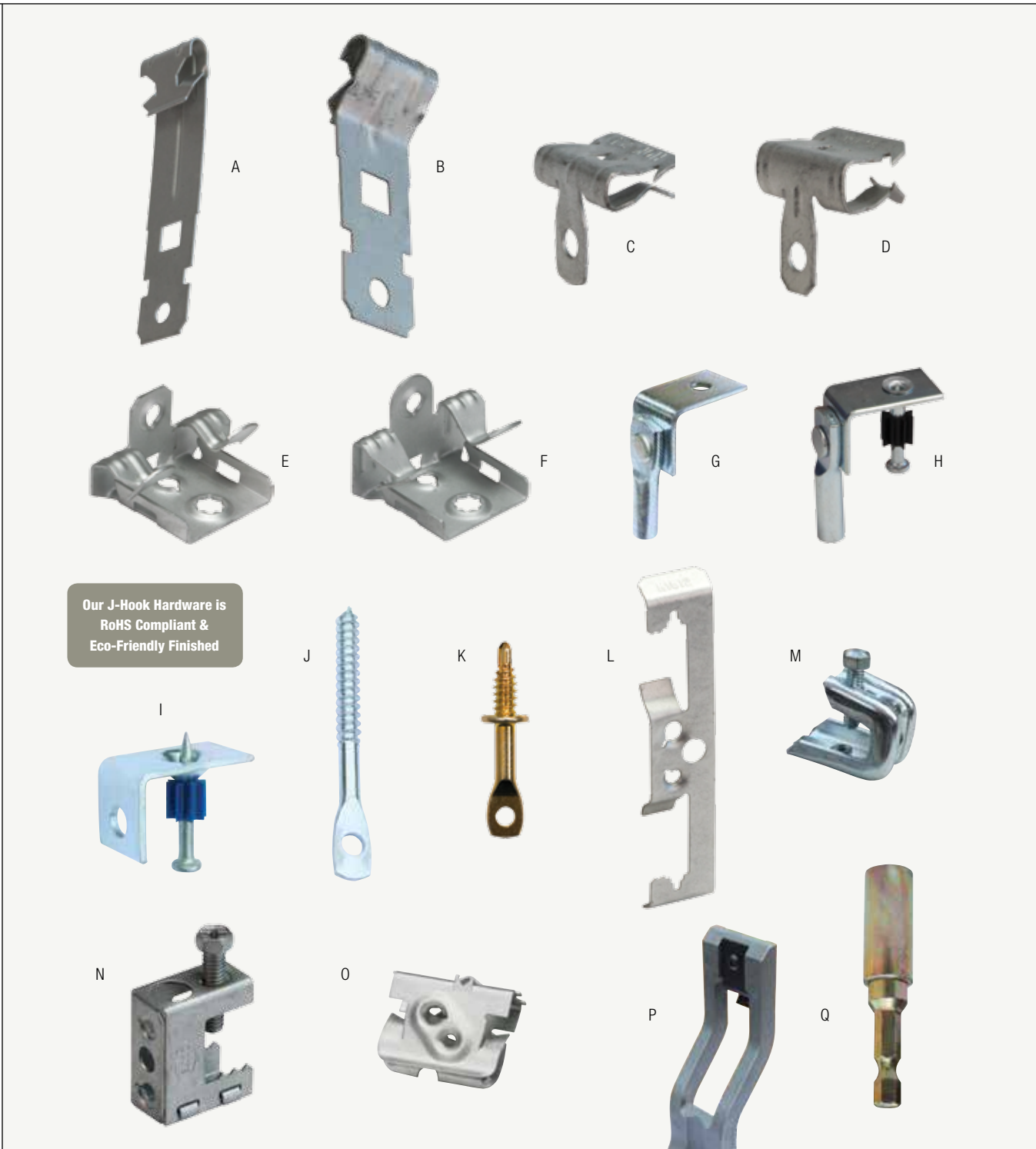

Our J-Hook Hardware is  
RoHS Compliant &  
Eco-Friendly Finished





	Part No.	Description	Qty
A	JH901-100	Vertical Overhang 180° with 1/4" Hole (C Purlin Applications)	100
B	JH902-100	Angled Overhang 45° with 1/4" Hole (Z Purlin Applications)	100
C	JH910-100	Hammer-On Beam Clamp 1/8" Thru 1/4" with 1/4" Hole	100
D	JH911-100	Hammer-On Beam Clamp 5/16" Thru 1/2" with 1/4" Hole	100
E	JH915-100	Spring Steel Hammer-On Beam Clamp, for flanges 1/8"-1/4" thick with 1/4"-20 Threaded Impression on Bottom and Back of Clamp	100
F	JH916-100	Spring Steel Hammer-On Beam Clamp, for flanges 5/16"-1/2" thick with 1/4"-20 Threaded Impression on Bottom and Back of Clamp	100
G	JH920-100	Angle Clip 90° - End Hook with 1/4"-20 Thread & 1/4" Hole	100
H	JH930-100	Angle Clip 90° - End Hook with 1/4"-20 Thread & Powder Actuated Nail	100
I	JH932-100	Angle Clip 90° - Powder Actuated Nail with 1/4" Hole	100
J	JH940-100	Eye Lag Screw - 3" Overall Length, 3/16" Hole & 1 1/2" Thread Length (Wood Applications)	100
K	JH941-100	Eye Lag Screw - 2" Overall Length I-LAG™ Brand Eye Lag Screw, 3/16" Hole & 3/4" Thread Length (16-22 Gauge, Sheet Metal Applications) ICC ESR-3135	100
L	JH960-100	Multi-Function Clip - Batwing with 1/4"-20 and 10-24 Impressions	100
M	JH965-50	Pressed Beam Clamp 1/8" Thru 1/2" Flanges, 1/4"-20 Treads	50
N	JH966-100	Spring Steel Beam Clamp for 1/8" Thru 1/2" Flanges with 1/4"-20 & 10-24 Impressions	100
O	JH967-100	All Purpose Clip, Hammer-On 1/8" Thru 1/2" Flanges with 1/4"-20 & 10-24 Impressions & accommodates Drive Rings	100
P	JH975	Installation Tool - Vertical (JH901-100) and Angled Overhang (JH902-100)	1
Q	JH980	Installation Tool - Eye Lag Driver – Fits Into Any Drill, Hex 1/4" Hex	1

## Bridle Rings

Support and secure your communication and other low voltage cables with these various sized Bridle Rings. Simple and effective. Constructed of solid low carbon steel. The perfect choice for cable management made easy!

Part #	Qty.	Description
JH802-100	100/box	10 x 24 - 3/4" ID
JH804-100	100/box	10 x 24 - 2" ID
JH807-100	100/box	1/4" x 20 - 1 1/4" ID
JH808-100	100/box	1/4" x 20 - 2" ID
JH809-50	50/box	1/4" x 20 - 4" ID
JH813-100	100/box	1/4" Wood Screw - 1 1/4" ID
JH814-100	100/box	1/4" Wood Screw - 2" ID

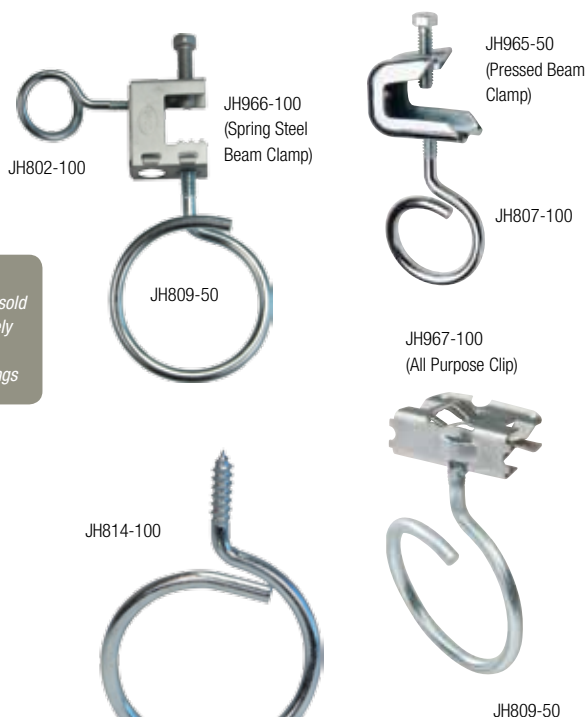

**NOTE:**  
Hardware sold separately from Bridle Rings

## Xtender Pole™ – *Speeds installation. Improves safety. Saves money.*

The professional cable installer's tool for easier overhead installations. A safer way to reach areas that previously were dangerous or inaccessible to ladders, scaffolding, and scissor lifts. Including vaulted ceilings, over stairwells, and through ceiling grid, all from the work floor.

### Features

- Install hanging hardware from work floor, improves safety and efficiency
- Patented All-In-One Adapter System for threaded rod, eye lag screws, wire, and jack chain
- Install multiple fastener types to a variety of ceiling structures – Elco®, Hanger Mate®, Buildex® Sammy Super Screws®, Powers Vertigo®
- Powered with any 3/8" or 1/2" drill
- Includes female hex adapter for 1/4" male driver and 5/8" hex adapter
- Video instructions for applications (Platinum Tools website)
- Tips & Instruction Booklet
- Xtender Pole – 12 (three 4' sections, ceilings up to 18')
- Xtender Pole – 18 (three 6' sections ceilings up to 24')

Part #	Description
JH711	Keyless Chuck Adapter, 3/8"
JH712	Xtender Pole™ – 12
JH718	Xtender Pole™ – 18
JH701	Female Hex Adapter – 1/4" Male Driver
JH702	Hex Adapter, Open End 3/8"
JH703	Hex Adapter, Female Open End 5/8"
JH705	1/2" NPT Adapter
JH707	Drill Driver Adapter
JH975	Installation Tool – Vertical & Angled Overhang

### Xtender Pole Applications

#### Hang wire and chain.

Install as many as 100 ceiling wires per hour.

#### Drive screws.

The 1/4" hex adapter transforms the Xtender Pole into a very long screwdriver.

#### Hang threaded rod.

The socket adapters work with 3/8" or 1/4" threaded rod up to 10 feet long.

**Assembled in the USA**  
with Globally Sourced Components

**1/2" Hex Adapter** is built into the Xtender Pole Adapter Head to be used with Elco HangerMate screws to install threaded rod.

## Xtender Pole™ – Accessories



### Adapters included:

- A) Female Open End 5/8" Hex Adapter – JH703**  
For installing ITW Buildex® Sammy Super Screws® and will work with Powers Vertigo®. For use with 1/4-20 and 3/8-16 threaded rod installation.
- B) Drill Driver Adapter – JH707**
- C) Female Hex Adapter – JH701**  
Use with any 1/4" hex bit

### Adapters & Accessories available:

- D) 1/2" NPT Adapter – JH705**  
Use with Installation Tool, P/N JH975, or any other tool requiring 1/2" NPT (National Pipe Thread).
- E) Installation Tool – JH975**  
Use for vertical and angled overhang.
- F) Hex Adapter, Open End 3/8" – JH702**  
Use to install threaded rod
- G) Keyless Chuck Adapter, 3/8" – JH711**

## BongoTies®

Handy ties for cables and other unruly items, BongoTies have unlimited uses. Simple, durable and made of high-quality, heavy gauge natural rubber and bamboo. The patented design allows for quick, secure, button-type fastening. Wrap a BongoTie around twice for small jobs or attach several ties together to secure large bundles.

### Applications

- Cords and Cables
- Office and Industrial
- Electronics and IT
- Outdoor Sports
- Hardware and Housewares
- Travel

Part #	Description
19501	BongoTies® Bag – 10 pieces



# Test & Measurement



## Net Chaser™ Ethernet Speed Certifier Tester

A complete solution to test and speed certify the data-carrying capabilities of Ethernet network cables up to 1 Gb/s. The Net Chaser tests for noise in the network, detects faults in the cable wiring, and ensures that cables are able to support the speed capabilities of active equipment.

- Speed Certification to IEEE Standards 802.3
- Cable Testing to TIA 568A/B

The Net Chaser's advanced networking features gives the clearest vision of network layout and interfaces between active components like servers, switches, routers, etc. Saves test reports and exports to PC's in PDF or CSV format.

- Pings specific IPs or URL addresses
- Traceroute
- CDP/LLDP
- DHCP
- VLAN
- Port Discovery

**MADE IN USA**  
with Globally Sourced Components



### TNC950AR

#### Kit Includes:

- Net Chaser Main Unit
- Net Chaser Active Remote
- Power Supply (2) (NA/EU/AU/UK)
- 4 GB SD Card
- Micro USB Cable
- FTP Patch Cable, 12" Cat5e (2)
- RJ45 Port Saver (2)
- F Connector Coupler, F81
- F-Jack to BNC Adapter (2)
- Hanging Strap and Clip (2)
- Large Shoulder Bag

Part #	Description
TNC950AR	Net Chaser™ Ethernet Speed Certifier Tester Kit

## Test and Speed Certify Ethernet Network Cables to 1 GB

### Active Remote

(TAR104)

- User-selectable ID #1-4
- Pass or fail indication
- Lithium-ion batteries

### Signal Quality Testing

- Length of cable distance to Opens and Shorts
- SKEW
- Echo Testing (Return Loss) – impedance mismatches
- Signal to Noise Ratio
  - Attenuation
  - Amplitude
  - Return Loss

### Performance and Speed Certification

- Supports IEEE 802.3 data transmission specifications to 1 Gb
- Test interconnect specifications per TIA 568A/B
- Measures the quality of the data transmission against set criteria on cable data-carrying capability in real time; 100Mbit/gigabit speeds
- Real-time testing on the performance capability of the cable

### TNC950DX

#### Kit Includes:

- Net Chaser Main Unit
- Net Chaser Active Remote
- Power Supply (2) (NA/EU/AU/UK)
- 4 GB SD Card
- Micro USB Cable
- FTP Patch Cable, 12" Cat5e (4)
- RJ45 Port Saver (2)
- Cable Assembly, RJ45 to 8 Way Alligator Clip (2)
- F-Jack to BNC Adapter (2)
- Hanging Strap and Clip (2)
- Hanging Pouch
- Protective Hard Case

Part #	Description
TNC950DX	Net Chaser™ Deluxe Test Kit

### Net Chaser Physical Features

- 3.5" color touch screen display
- Compact form factor
- 3rd generation rechargeable lithium-ion batteries
- Benchtop, handheld, or hung up
- Uses modular cable interfaces
- SD card for data file transfer of cable tests
- Field-upgradeable firmware
- Built-in stand
- Multilingual: English, French, Spanish, German, Italian, Chinese(TR)



## Net Prowler™ Cable and Network Tester

This cable and advanced network tester takes all the features and functionality of the Cable Prowler and adds the capability to identify, monitor, and troubleshoot LAN issues associated with physical layer and link conditions in the network.

- Supports IPV4 and IPV6 protocols
- Verifies DHCP connectivity and DNS
- Pings IPV4, IPV6, and URL addresses
- CDP, LLDP, and VLAN detection
- Detects presence of PoE and class of PoE per IEEE 802.3af/at with load test for voltage drop
- Detects and reports current link speed and link capabilities for active Ethernet drops up to 1 Gb/s
- Link light to identify location on a hub/switch/router port
- Tests CAT3/5e/6/6a Ethernet cable configuration and verifies connectivity while conducting tests for opens, shorts, miswires, split pairs, and reverses
- Supports up to 8 testing and ID remotes for network and telephone cables
- Supports up to 20 network and coax ID-only mapping remotes
- Ability to define Network test name, cable name, save, and print all results (cable testing and network testing)



### Physical Features

- High resolution full color graphical display
- Displays wiremap in color per TIA-568A/B color codes, in pin or pair order (configurable)
- Protective rubber boot and optional kickstand/hanging strap
- Micro USB connector (to export cable reports), RJ45 connector, and coax connector
- Multilingual (English, French, Spanish, German, Italian)



## TNP850K1

### Kit Includes:

- Net Prowler Main Unit
- Cable Tester Smart Remotes, #1-8
- ID Only Coax Remotes, #1-8
- ID Only Network Remotes, #1-12
- Micro USB Cable
- Cable Assembly, RJ45 to Alligator Clip
- No-Fault, RJ12 Cable (2)
- RJ45 Port Saver
- F Connector Coupler F81 (2)
- BNC Adapter Kit
- Alkaline AA Batteries
- Durable Plastic Case

Part #	Description
TNP850K1	Net Prowler™ PRO Test Kit



## TNP800

### Kit Includes:

- Net Prowler Main Unit
- Cable Tester Smart Remotes, #1-8
- ID Only Coax Remotes, #1-20
- ID Only Network Remotes, #1-20
- F Connector Coupler F81 (2)
- No-Fault, RJ12 Cable (2)
- Micro USB Cable
- Alkaline AA Batteries
- Large Shoulder Bag

Part #	Description
TNP800	Net Prowler™ Deluxe PRO Test Kit



LLDP Search Screen



Identify, Monitor, and Test LAN Issues

CPD Search Screen



Port Test Screen



## TNP700

### Kit Includes:

- Net Prowler Main Unit
- Cable Tester Smart Remote, #1
- ID Only Coax Remotes, #1-5
- ID Only Network Remotes, #1-5
- F Connector Coupler F81
- No-Fault, RJ12 Cable (2)
- Micro USB Cable
- Alkaline AA Batteries
- Hanging Pouch

Part #	Description
TNP700	Net Prowler™ Network Test Kit

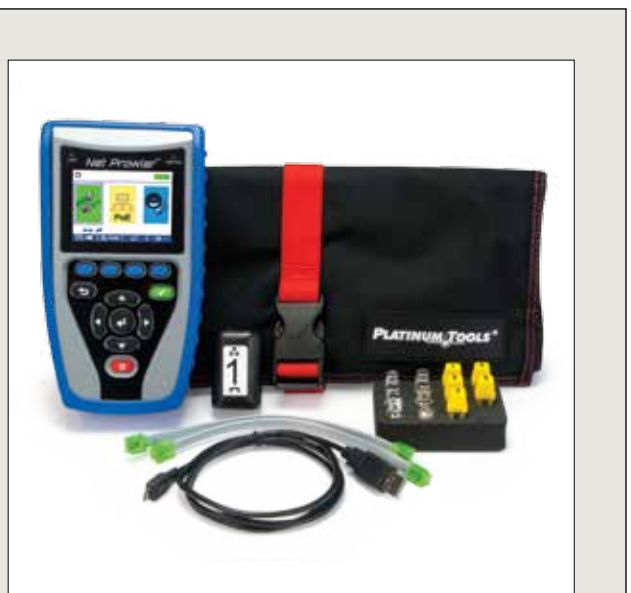

## Cable Prowler™ Cable Tester

Provides full color cable testing and report management for Cat3, Cat5e, Cat6, Cat6A, coax, and telephone cable types. The Cable Prowler combines the functions of a high-end cable tester and length measurement tester, the capability to identify link status, link capability, and PoE detection. All of this functionality is combined with internal memory to save, download, and output results in full color.

### Technical

- Displays length measurement for each pair in feet or meters using TDR technology
- Detects presence of PoE and class of PoE per IEEE 802.3af/at with load test for voltage drop
- Detects and reports current link speed and link capabilities for active Ethernet drops up to 1 Gb/s
- Tests Ethernet cable configuration and verifies connectivity while conducting tests for opens, shorts, miswires, split pairs, and reverses
- Supports up to 8 Testing and ID Remotes for network and telephone cables
- Supports up to 20 network and coax ID only remotes
- View saved cable tests
- Full color graphical wire-mapping
- Ability to define cable name, save cable tests, and print ALL results (cable testing and network testing)
- Multilingual (English, French, Spanish, German, Italian)

### Applications

- Measure cable length and length to faults using TDR technology
- Network testing of link capability, link status, and link light
- Test PoE to ensure adequate power for powered devices such as VoIP phones
- Conduct single ended and remote cable tests with display of PASS, wire map, ID, and faults for network and coax cables
- Tone and trace cables
- Locate unlabeled network and coax cables with up to 20 remote identifiers
- Test multiple (up to 8) network and telephone drops with testing and identifier remotes
- Define a cable name for your cable test, save every cable test, and export to your computer for record keeping and printing



## TCB360K1

### Kit Includes:

- Cable Prowler Main Unit
- Cable Tester Smart Remotes, #1-8
- ID Only Coax Remotes, #1-8
- ID Only Network Remotes, #1-12
- Micro USB Cable
- Cable Assembly, RJ45 to Alligator Clip
- No-Fault, RJ12 Cable (2)
- RJ45 Port Saver
- F Connector Coupler F81 (2)
- BNC Adapter Kit
- Alkaline AA Batteries
- Durable Plastic Case

Part #	Description
TCB360K1	Cable Prowler™ PRO Test Kit





## TCB400

### Kit Includes:

- Cable Prowler Main Unit
- Cable Tester Smart Remotes, #1-8
- ID Only Coax Remotes, #1-20
- ID Only Network Remotes, #1-20
- ToneSeeker Tone Tracer Probe
- F Connector Coupler F81 (2)
- No-Fault, RJ12 Cable (2)
- Micro USB Cable
- Alkaline AA Batteries
- Large Shoulder Bag

Part #	Description
TCB400	Cable Prowler™ Deluxe PRO Test Kit



TCB400

## Full Color Cable Testing and Report Management

Cat3/5e/6/6A, Coax, and Telephone

### Fail

T568B	
1 2 3 6 4 5 7 8 S	FAIL ID-1
1 2 3 6 4 5 7 8 S	VoP 68.0 %
Pair 1-2	Length = 5.5 ft
Pair 3-6	Length = 5.7 ft
Pair 4-5	Length = 5.8 ft
Pair 7-8	Length = 5.5 ft

### PoE Testing

PoE	
Link Capability	Link Flow Control
10Base-T	Full / Half Duplex
100Base-TX	Full / Half Duplex
1000Base-T	Full / Half Duplex
Connected at	PoE + A 25.5W Max
100 Base-TX	57.9 V Min Load
MDI FDX	56.1 V Max Load

## TCB300

### Kit Includes:

- Cable Prowler Main Unit
- Cable Tester Smart Remote, #1
- ID Only Coax Remotes, #1-5
- ID Only Network Remotes, #1-5
- F Connector Coupler F81
- No-Fault, RJ12 Cable (2)
- Micro USB Cable
- Alkaline AA Batteries
- Hanging Pouch



TCB300

Part #	Description
TCB300	Cable Prowler™ Cable Test Kit

## VDV MapMaster™ 3.0 Cable Tester

Combines continuity testing, mapping, generating tones, and length measurement functions into a single easy-to-use unit for installation, troubleshooting, and maintenance for telco, network, or coax cable. The backlit display, glow-in-the dark keypad and a built-in flashlight helps you to work in the dark. Whether your jobs are commercial or residential, the versatility and added features of the VDV MapMaster 3.0 makes it a best value cable verifier for the professional installer!

### Features

- Detects open, shorts, miswires, reverses, and split pairs
- Tests to T568A/B wiremap configuration: shorts, opens, miswires, reverses, and split pairs
- Single-ended testing for shorts and split pairs
- Measures Length in Feet/Meters
- Identifies cable location on active ports using flashing Port Link Light
- Easy to read, backlit LCD screen with large icons, glow-in-the-dark keypad and built-in LED flashlight for use in dark areas
- Verifies continuity for multiple cable types (LAN, phone, and video)
- Audible beep for additional feedback
- Identify up to 20 network or coax cable runs at a time
- Measures cable length, distance to opens, and breaks in specific wires, pairs, or all wires simultaneously
- Master remote stored in main unit
- Voltage detection warning icon
- Continuous loop test mode for trouble shooting
- Auto-off and timed backlight in any mode for low power consumption and long battery life
- Audible tone generation, 4 selectable cadences



Pass

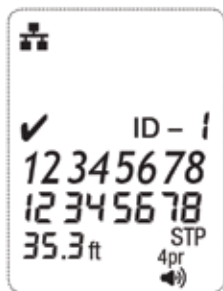

Open and Short

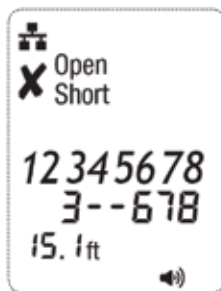

Port Link Light

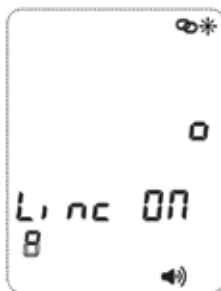

See pages 88 and 89 for the VDV MapMaster Accessories



Easy to read, backlit LCD screen with large icons, glow-in-the-dark keypad, and built-in LED flashlight for use in dark areas.

Ports

Bottom



Top



Part #	Description
T130	VDV MapMaster™ 3.0 Cable Tester

### T130K3

**Kit Includes:**

- VDV MapMaster 3.0 Main Unit
- ToneSeeker Tone Tracer Probe
- RJ45 Port Saver
- Cable Tester Smart Remotes, #2-8
- ID Only Network Remotes, #1-20
- No-Fault, RJ12 Cable (2)
- FTP Patch Cable, 5" Cat6, (8)
- Cable Assembly, RJ45 to Alligator Clip
- BNC Adapter Kit
- 9V Battery
- Large Shoulder Bag

Part #	Description
T130K3	VDV MapMaster™ 3.0 Cable Tester Deluxe PRO Kit



Part #	Description
T130K1	VDV MapMaster™ 3.0 Cable Tester Kit

### T130K1

**Kit Includes:**

- VDV MapMaster 3.0 Main Unit
- RJ45 Port Saver
- ID Only Network Remotes, #1-20
- No-Fault, RJ12 Cable (2)
- FTP Patch Cable, 5" Cat6, (2)
- Cable Assembly, RJ45 to Alligator Clip
- BNC Adapter Kit
- 9V Battery
- Hanging Pouch



Part #	Description
T130K2	VDV MapMaster™ 3.0 Cable Tester PRO Kit

### T130K2

**Kit Includes:**

- VDV MapMaster 3.0 Main Unit
- RJ45 Port Saver
- Cable Tester Smart Remotes, #2-8
- No-Fault, RJ12 Cable (2)
- FTP Patch Cable, 5" Cat6, (2)
- Cable Assembly, RJ45 to Alligator Clip
- BNC Adapter Kit
- 9V Battery
- Hanging Pouch

## VDV MapMaster™ 2.0 Cable Tester

Combines continuity testing, mapping, tone generation, and length measurement functions in a single tester. Capable of identifying and mapping 19 locations at one time. Whether your jobs are commercial or residential, the versatility and added features of the VDV MapMaster 2.0 makes it an installer's best friend!



### Features

- Measures length of entire cable and individual wire pairs
- Measures distance to an open
- Tests and indicates pins with shorts, opens, reversals, miswires, and split pairs
- Tests voice (6 wire), data (8 wire), and video (coax)
- Easy to read, extra large 7-segment LCD screen with large icons
- Displays 'Pass' icon for correctly wired T568A/B and crossover/uplink
- Tone generator with selectable tone cadence and selectable pins carrying tone
- Displays 'Pass' icon for correctly wired 6-pin telephone plus 'Rev' for reverse-pinned
- Map 19 locations at one time
- RJ (Voice & Data) Master Remote stores in bottom of case
- Low power consumption for long battery life
- Auto power-off

- Test ✓
- Map ✓
- Measure ✓
- Tone ✓



### Technical

- RJ Cable Length: 1000'
- Minimum cable length for split pairs detection: 1.5'
- Maximum coax cable length: Cable resistance varies
- Size: 6.4 x 2.8 x 1.4"
- Weight: 9.0 oz. (Including battery and remote)
- Operating Temperature: 32° to 122° F
- Storage Temperature: -4° to 140° F
- Humidity: 10% to 90% non-condensing
- Battery Life Active: 425 hours (9V alkaline)

### T129K1

#### Kit Includes:

- VDV MapMaster 2.0 Main Unit
- ID Only Coax Remotes, #1-8
- ID Only Network Remotes, #1-12
- F Connector Coupler F81 (2)
- Cable Assembly, RJ45 to Alligator Clip
- No-Fault, RJ12 Cable
- RJ45 Port Saver
- BNC Adapter Kit
- 9V Battery
- Durable Plastic Case



T129K1

See pages 86 and 87 for the VDV MapMaster 2.0 Accessories.

### T129

#### Kit Includes:

- VDV MapMaster 2.0 Main Unit
- ID Only Coax Remotes, #1
- ID Only Network Remotes, #1
- F Connector Coupler F81
- 9V Battery

#### Part # Description

T129 VDV MapMaster™ 2.0

## RECON™ Butt Set/Test Set

The RECON is the first true 21st century telecommunication line analyzer. It is a field instrument that delivers more information of online conditions and status than any other test set on the market.

- **Advanced data detection and identification**
- **Large backlit display for low light environments**
- **Glow-in-the-dark keypad**
- **100% Data Safe**
- **Rugged weatherproof case, IP54 Standard**
- **Drop-proof (drop tested at 20ft)**

### Features

- Multilingual (English, French, Portuguese, Spanish)
- Amplified speaker with volume adjustment
- Adjustable earpiece volume, hearing aid compatible
- Microphone mute with toggle On/Off locking feature
- Soft key menu system
- Cushion boot for extra protection
- Backlight 0 to 100% adjustable with On/Off option
- Meets IP54 Water Resistance Standard

### Functions

- Off-hook current and polarity
- On-hook voltage and polarity
- Ring amplitude and frequency
- On-hook and call waiting Caller ID info
- Amplified Line Monitor for volume levels comparable to "off-hook" operation
- 8 number stored memory with Alpha/Numeric Tags
- Fuel gauge battery condition
- Continuous polarity indication
- Caller ID/Call Waiting and Caller ID Error Detection
- Tone and Pulse dialing
- Configurable Auto Off in all modes
- Detects and identifies DSL and T1 lines
- Last number dialed, redialed, or received

Part #	Description
T62	RECON™ Test Set
4007	Hanging Pouch
6070K1	Replacement Cord Set Kit

**RECON  
Test Set  
(P/N T62)  
Includes:**

- **RECON Butt Set**
- **Cord Set: 60 inch Bed-of-Nails and No-Fault RJ12 with Dust-Cap**
- **AAA Alkaline Batteries**

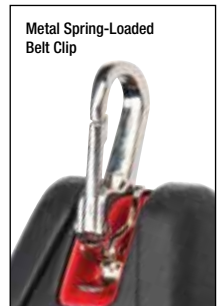

### Cord Set (P/N 6070K1) Includes:

- **Angled Bed-Of-Nails with Piercing Clips**
- **No-Fault RJ12 Cord Set with Dust-Cap**



## LANSeeker™ Cable Tester

The LANSeeker is a fast, rugged cable tester and tone generator in one unit. It displays cable test results using LED indicators on the main and remote unit. An easy-to-use professional grade tool, the LANSeeker is a must have for residential and commercial cable installers. When the unit senses a connection between the main and remote unit, the battery-saving auto-on feature initiates test results within 2 seconds. The tester automatically powers off within 5 seconds of the cable being disconnected. LANSeeker tests for shorts, opens, miswires, reversals, and split pairs and can display connection and fault information on a pair-by-pair basis. It also generates audio tones for use with tone tracers on all pairs.

### Features

- Displays cable test results on main and remote units in less than 2 seconds
- Immediately detects shorts by just plugging in one end of a cable to the tester
- Identifies shorts, opens, miswires, reversed, and split pairs
- No On/Off switch, automatically starts test when a connection is made between main and remote units
- Debug mode diagnoses and displays fault one pair at a time
- Built in tone generator
- Self-stored remote
- Cable types: shielded or unshielded, Cat3, Cat4, Cat5, Cat5e, Cat6, and Cat6A
- Max cable length for testing: 305m (1,000ft)



### Detachable Remote

Used for mapping and testing cables.

(Patch cables not included)



Voice,  
Data, and  
IP Video



Cable Ports

Part #	Description
TP500C	LanSeeker™ Cable Tester

### Additional Accessories:

Part #	Description
610030	FTP Patch Cable, 5" CAT6
TP150	Tone & Probe Kit
202010J	CAT6 EZ-RJ45 Connectors
706LA-1	CAT6 EZ-SnapJacks
4003PT	Cable Tester Belt Pouch
TP500MRC	LANSeeker Master Remote

## ToneMaster™ and ToneSeeker™

The Platinum Tools ToneMaster high-power tone generator enables signal detection over 20 miles away and makes hearing tone through walls and enclosures easier with multiple tones and power levels suited for network, signal wire, coax, and telephone cable applications. Four tone amplitude levels include normal and half plus, high-powered normal, and half, with the half amplitude unbalanced for stronger signal effect on twisted pairs. In addition, depending on test requirements, three distinctly different tone cadences can be selected from the front panel. Paired with the Platinum Tools ToneSeeker, the ToneMaster makes easy work of tracing and locating cables and cable ends.

### Features

#### ToneMaster High-Powered Tone Generator

- 700% more power than standard tone generators
- Unbalanced tone mode supports longer distances on twisted pair cables
- Constant amplitude output ensures no signal decrease as battery discharges
- Auto-off for battery conservation
- Full talk battery to power a dry line
- Tone may be added in any mode
- Models available with molded-in alligator clips or molded-in angled bed-of-nails (ABN) clips
- Lanyard attachment point

#### ToneSeeker Tone Tracer Probe

- Slim ergonomic shape, balanced weight
- Volume thumbwheel
- Recessed "Push-to-Trace" button
- Tip replacement without opening case
- Battery-low Indicator
- Lanyard attachment point



TG210K1

Includes Belt Pouch, 9V Batteries, RJ12 Cable, and User Manual.

## Professional Tone and Probe Kits

### TG210K1

#### Kit Includes:

- ToneMaster w/Alligator Clips
- ToneSeeker
- No-Fault, RJ12 Cable
- Tone and Probe Belt Pouch

Part #	Description
TG210K1	Professional Tone and Probe Kit w/Alligator Clips, Belt Pouch

### TG220K1

#### Kit Includes:

- ToneMaster w/ABN Clips
- ToneSeeker
- No-Fault, RJ12 Cable
- Tone and Probe Belt Pouch

Part #	Description
TG220K1	Professional Tone and Probe Kit w/ABN Clips, Belt Pouch



Part #	Description
TG210C	ToneMaster™ High-Powered Tone Generator w/Alligator Clips
TG220C	ToneMaster™ High-Powered Tone Generator w/ABN Clips
TP250C	ToneSeeker™ Tone Tracer Probe

**700% More Power**  
Than Standard Tone  
Generators

## Coax Clarifier™ Coax Mapper and Tester

Discern the layout of dark networks, locate faults on individual cable runs, and measure cable run lengths. Measure the Return Loss quality of an entire coax network and identify remotes through splitters.

### Features

- Identifies cable faults
- Measures dark coax network quality
- Detects Coax RF Remotes through splitters
- Locates splitters in the system
- Tests and grades splitter performance
- Measures cable length up to 1,500'
- Wiremaps up to 12 ID Only remote locations



TCC220 includes 4 remotes.  
TCC200 includes 2 remotes.

### TCC220

#### Kit Includes:

- Coax Clarifier Main Unit
- Coax RF Remotes, #1-4
- ID Only Coax Remotes, #1-12
- Cable Assembly, Screw-On F Jack to Push-On F Plug Cable - 12"
- Adapter, BNC Female to Female
- Adapter, F Jack to Push-On Plug (5)
- F Connector Coupler F81 (3)
- F Male Terminator 75 Ohm(4)
- Alkaline AA Batteries
- Hanging Pouch

#### Part # Description

TCC220 Coax Clarifier™ with 4 Coax RF Remotes Kit

### Coax Run Mapping

Maps runs through splitters to show an accurate picture of the coax system layout using up to 4 Coax RF Remotes. Up to 12 ID Only Coax Remotes are also available for wiremapping on home runs.

### Cable Length

Determines cable run length and reports the length to an open or unterminated cable.

### Quality of Network

Measures overall network quality and clearly depicts network reading as both a bar graph and a digital return loss number, measured in dB.

### Tone Tracing

Traces coax runs with four unique tones to quickly distinguish between respective outlets.



### TCC200

#### Kit Includes:

- Coax Clarifier Main Unit
- Coax RF Remotes, #1-2
- ID Only Coax Remotes, #1-4
- Cable Assembly, Screw-On F Jack to Push-On F Plug Cable – 12"
- Adapter, BNC Female to Female
- Adapter, F Jack to Push-On Plug (3)
- F Connector Coupler F81 (3)
- F Male Terminator 75 Ohm (4)
- Alkaline AA Batteries
- Hanging Pouch

#### Part # Description

TCC200 Coax Clarifier™ with 2 Coax RF Remotes Kit



## 4MAPPER™ Coax Mapper and Tester

The fast and easy solution to troubleshoot and identify multiple coax cables. Also quickly identify and track up to 4 cable runs at a time from the distribution box. Easy to use, simply place colored remotes at the wall plate end and use the 4MAPPER at the distribution box.



### Features

- EZ 1-button design
- Displays Pass, Open, or Short
- Integrated tone generator
- Automatic power off
- Line voltage warning LED
- Flashing low battery LED
- Ultra bright, high intensity LEDs,
- Includes 4 color coded, push-on design F Remotes
- Indicates what color remote is at the other end of the cable
- Small and compact, fits in the palm of the hand
- Long battery life
- Cable length for testing: 0 to 3,000'.

Part #	Description
T104C	4MAPPER™ Tester

### 4Mapper Accessories

Part #	Description
T101C	Coax Remote Kit for 4MAPPER™
T103C	BNC Adapter Kit



T104C

**Tone it!  
Track it!  
Test it!**

CATV  
Satellite  
Security  
AV Installations



T101C

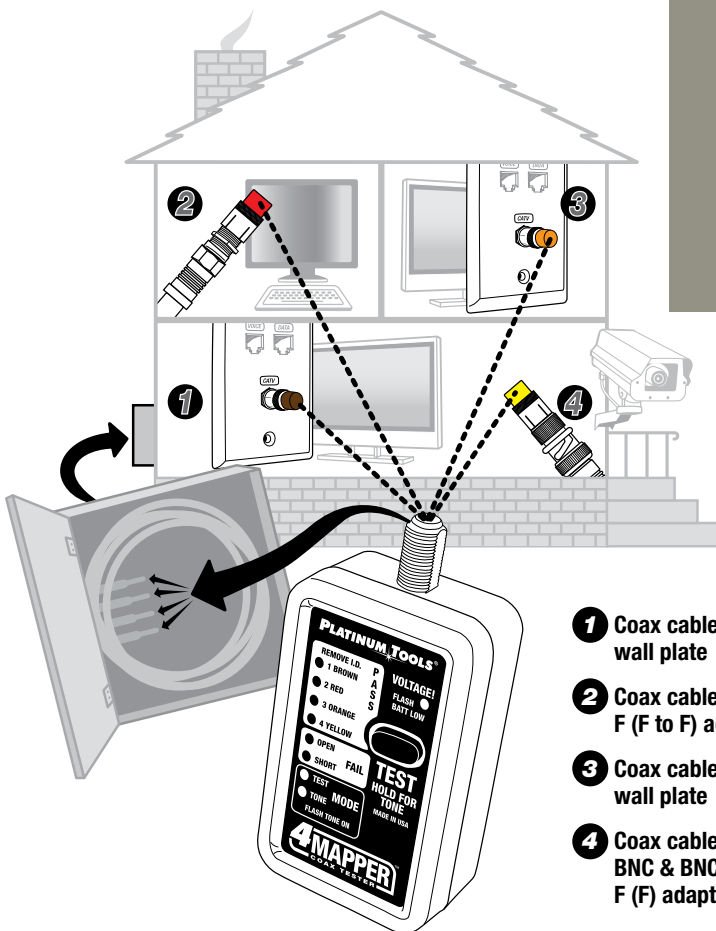

- 1** Coax cable to wall plate
- 2** Coax cable with F (F to F) adapter
- 3** Coax cable to wall plate
- 4** Coax cable with BNC & BNC (F) to F (F) adapter

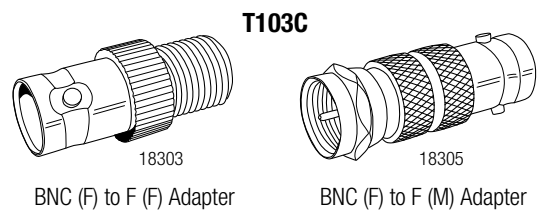

T103C

18303

18305

BNC (F) to F (F) Adapter

BNC (F) to F (M) Adapter

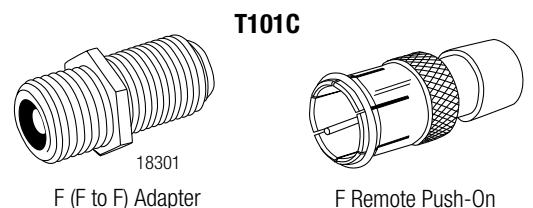

T101C

18301

F (F to F) Adapter

F Remote Push-On

## Snap Shot™ Fault Finder/Cable Fault Locator

Accurately measures cable length, impediments in the cable, and conditions at the end of every wire in your data, power or communications/video system up to 3,000'. Advanced Spread Spectrum TDR technology (SSTDR) works in all wire environments and is immune to voltage, current, or data stream disruptions.

### Features

- Works on energized cables
- Measures cable length or distance to fault from one end
- Measures cable distance on spool
- Accuracy of 1% or better
- Calibrates NVP values
- Internal memory for storing up to two of your most used cable NVP values
- Large backlit LCD display
- Built-in tone generator for cable tracing and identification
- Loop test for continuous testing
- Displays length reading in feet or meters
- Auto-off to preserve battery life



TCA001 Cable Assembly, Insulated Push-On F to RJ45 Plug



TCA003 Cable Assembly, Insulated Push-On F to Alligator Clips



TCA002 Cable Assembly, Insulated BNC to Alligator Clips

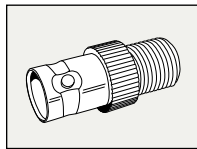

18303 BNC Female to F Female

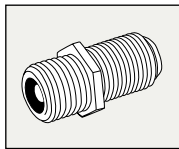

TAD001 F Connector Coupler, High Performance F81

### TSS200

#### Kit Includes:

- Snap Shot Main Unit
- Cable Assembly, Insulated Push-On F to RJ45 Plug
- Cable Assembly, Insulated BNC to Alligator Clips
- Cable Assembly, Insulated Push-On F to Alligator Clips
- F Connector Coupler, High Performance F81
- Adapter, F BNC Female to F Female
- Hanging Pouch
- Alkaline AA Batteries

#### Part # Description

TSS200 Snap Shot™ Kit

### Memory

Holds up to two different NVP values for multiple cable tests.

### Calibration

Ability to calibrate NVP for any cable.

### Tests

Tests length, opens, or shorts present on the cable, up to 3,000'.

### Tone Generation

Produces four different tones for locating cables.

### Fault Finding/Cable Length Measurement



MADE IN USA  
with Globally Sourced Components

## Tone and Probe Set

With its steady tone, push-to-scan button, and a clear loudspeaker, quickly trace and identify cable locations on jacks or through walls. Wire bundles are easily penetrated with the tapered probe tip and the probe volume is controlled with a thumbwheel. With common send and receive frequencies, the TP150 is versatile enough to be used with other tone generators or probes.

### Probe Features

- Recessed push-button activates tone scanning when needed
- Tapered tip allows easy penetration of cable bundles
- Side thumb wheel adjusts volume and turns off power to reserve battery power
- Probe Sensitivity: 100Hz~300KHz

### Tone Generator Features

- Slide switch to select TONE/OFF/CONT
- Continuity mode to verify if a wire is broken
- Alligator clips to test pairs and an RJ11 connector for phone lines
- Tone Generator Output: 1.5KHz square waveform

Part #	Description
TP150	Tone and Probe Set

Includes Carrying Case, 9V Batteries, and User Instructions



RJ11 connector for phone lines

Alligator clips to test pairs

**Designed Specifically for Easy Cable Tracing and Identification.**

## PoE Detector

This pocket sized tool detects PoE end/mid-span voltages on network cables. LED indicators instantly show "GO/NO-GO" detection on PoE networks. Plug cables into the built-in RJ45 jack or use the included patch cord to detect voltage in wall jacks. Differentiates between End-span power which is supplied from PoE equipment (PoE switch or router) and mid-span voltage from injectors.

### Features

- Go/No-Go PoE Voltage Detector
- Voltage pair detection 1/2, 3/6, 4/5, 7/8
- Bright LED indicators
- Plug direct or use included patch cord
- 802.3af or 802.3at compatible
- Pocket-size

Part #	Description
TPS100C	PoE Detector



Cable & Network Test Comparison



4Mapper

Snap Shot

Coax Clarifier



Product Category	Coax Mapper	Cable Fault Locator TDR	Coax Mapper Coax Tester
Ethernet Speed Certification to 1 Gb/s			
BER Test (Bit Error Rate), Signal to Noise Ratio, Skew			
Active Ethernet (Link Capability & Link Status)			
Detects PoE/PoE+, PoE Mode, and load test for voltage drop			
VLAN Discovery			
Discovery Protocols			
Port Discovery			
Ping (URL & Manual IP Address Entry)			
DHCP			
Network Mapping (displays device name, IP & MAC on network)			
TCP/UDP Connectivity Test			
Traceroute			
VoIP Qualification			
Link Light (Flash LED light on switch port)			
One Ended Test		✓	
Tone Generation	✓	✓	✓
Detect Length to Opens & Shorts		✓	Opens only
Max Length 1,500 ft (457 m)		Up to 3,000 ft.	✓
Verifies Continuity (RJ45, Coax)	Coax Only	2 Wire, Coax	Coax Only
ID Remotes (ID Only) Network & Coax	Coax Only Up to 4		Coax Only Up to 12 Coax RF Remotes Only Up to 4 Available
Testing & ID Remotes Network			
Measures Quality of Dark Coax Network (75 Ohm)			✓
Measures Quality of Coax Splitters (75 Ohm)			✓
Detects Coax Splitter (75 Ohm)			✓
Locates Remotes through Coax Splitters (75 Ohm)			✓
Interface Connection	F Conn	F Conn/Clip Set	F Conn
Kickstand/Hanging Clip			
Display Type	LED Lights	Backlit Monochrome LCD	Backlit Monochrome LCD
Save and Export Test Results			
Battery Type	6V	AA	AA

LanSeeker	VDV MapMaster 2.0	VDV MapMaster 3.0	Cable Prowler	Net Prowler	Net Chaser
					
RJ45 Cable Tester	VDV Cable Tester	VDV Cable Tester	Cable Tester	Network Tester Cable Tester	Ethernet Speed Certifier Network Tester
					✓
					✓
			✓	✓	✓
			✓	✓	✓
				✓	✓
				(CDP, LLDP)	CDP, LLDP)
				✓	✓
				✓	✓
				✓	✓
				✓	✓
					✓
					✓
		✓	✓	✓	✓
✓		✓	✓	✓	✓
✓	✓	✓	✓	✓	✓
	Opens only	Opens only	✓	✓	✓
	✓	✓	✓	✓	✓
RJ45 Only	✓	✓	✓	✓	✓
	Up to 19	Up to 20	Up to 20	Up to 20	Up to 20
1 Remote	Up to 8	Up to 8	Up to 8	Up to 8	Up to 8
RJ45	RJ45/F/RJ11	RJ45/F/RJ11	RJ45/F Conn. Optional	RJ45/F Conn. Optional	RJ45/F Conn. ✓
LED Lights	Monochrome LCD	Backlit Monochrome LCD	Color	Color	Color Touch
			Up to 256 tests	Up to 256 tests	Unlimited
9V	9V	9V	AA	AA	Rechargeable Lithium-ion

## Fault Trapper™ Arc Fault Circuit Tester and Fault Locator

For the first time, you can detect the type of fault and locate the position of an electrical “event” that causes intermittent or persistent circuit breaker trips and No Fault Found (NFF) conditions, thus giving you the critical information needed to reduce call backs for circuit breaker trips.

### Features

- In-line monitoring of energized dedicated circuits up to 300 VAC and 40 amps
- Allows unattended monitoring of intermittent or sustained electrical events
- No splicing – plug in with existing wiring
- Identifies opens, shorts and arc faults
- Detects the last event whether or not the breaker trips
- Runs on in-line power in monitor mode
- Fault location reported as distance from the Fault Trapper in feet/meters
- Easy-to-use three-button operation
- Backlit LCD display for dark areas
- Back-up battery allows capture of breaker trips/unpowered display of results
- Accuracy: Up to 97%
- Maximum Length: 300 ft on NM-B or Wire in Conduit



### See Beyond The Circuit Breaker

Spread Spectrum Time Domain Reflectometry (SSTDTR) to monitor live circuits.

Allows unattended monitoring to identify electrical events.



with Globally Sourced Components

### TFT100

#### Kit Includes:

- Fault Trapper Arc Fault Circuit Tester and Fault Locator
- Banana Plug Assembly
- Plug In Terminal Block
- Insulated Screwdriver

#### Part # Description

**TFT100** Fault Trapper™ Arc Fault Circuit Tester and Fault Locator

## AC Voltage Detector

### Features

- Easy LED and audible warnings
- Pocket-size and pen-shaped
- Contactless AC voltage detection
- Audible and LED indicators
- Double-molded rugged housing
- Illuminated tip for dark areas

Part #	Description
T305C	AC Voltage Detector



## GFCI Socket Tester

### Features

- Press-to-Test button to check GFCI socket
- Troubleshoot 110-125VAC electric sockets for possible faults
- Ideal for new or faulty 3-Prong/GFCI electric sockets
- Bright LED indicators for indoor or outdoor use

Part #	Description
T302C	GFCI Socket Tester



## 110V Outlet Tester

### Features

- LED indicators for good or faulty wiring
- Troubleshoot 110-125VAC electric sockets for proper wiring
- Ideal for new or faulty 3-Prong/GFCI electric sockets
- Bright LED indicators for indoor or outdoor use

Part #	Description
T301C	110V Outlet Tester



## Tester Accessories:

### Network Remotes:

#### ID Only Network Remotes

ID Only Network Remotes saves cable technicians time locating unlabeled cabling. These remote sets used with a Platinum Tools cable tester will display ID (identification) numbering only. They are not cable testing remotes.

**T128C** – ID Only Network Remotes, #1-12

**T121C** – ID Only Network Remotes, #1-19

**TRK220** – ID Only Network Remotes, #1-20



T128C



T121C



TRK220

#### Replacement Master Remotes

**T130MRC** – VDV MapMaster 3.0 Master Remote

**T124C** – VDV MapMaster 2.0 Master Remote

**TP500MRC** – LANSeeker Master Remote



#### Net Chaser Active Remote

**TAR104** – User-selectable ID #1-4.  
Pass or fail indication.



### Coax Remotes:

#### ID Only Coax Remotes

ID Only Coax Remotes saves cable technicians time locating unlabeled cabling. These remote sets used with a Platinum Tools cable tester will display ID (identification) numbering only. They are not cable testing remotes.

**T127C** – ID Only Coax Remotes, #1-8

**T120C** – ID Only Coax Remotes, #1-19

**TRK120** – ID Only Coax Remotes, #1-20



T127C



T120C



TRK120

#### Coax Remote Kit for 4MAPPER

**T101C** – Includes 4 custom F remotes with holster and 1 F (F to F) adapter. Replacement Kit for the 4MAPPER coax tester.



### Additional Accessories:

**F Connector Coupler F81**  
18301



#### BNC Adapter Kit

**T103C** – Includes four BNC (Female) to F (Female) adapters and one BNC (Female) to F (Male) adapter. Works with all Platinum Tools cable testers.



#### RJ45 to Alligator 12" Cable

**T125C** – Use when shooting tone via the network port. Cable conductors are terminated on contact #1 and #2, so program your Platinum Tools cable tester to shoot tone on pair 1 and 2.



#### No-Fault, RJ12 Cable

**T126C** – 7.5" Special RJ12 to RJ12 The No-Fault Cable uses no-fault RJ12 connectors on both ends to assure no damage to the RJ45 jacks. It is the ideal patch cable to use when mapping or shooting tone.



#### RJ45 Port Saver

**21025C** – Extend the life of your tester by using the RJ45 Port Saver as your sacrificial cable. This eliminates the wear and tear from constantly plugging in and out of the tester port.



**12" Screw-On F Jack-to-Push-On Plug Cable Assembly**  
TCA004



#### Micro USB Cable

**TCA007** – Connects Cable Prowler, Net Prowler, and Net Chaser to computers to export test results.



#### Network Accessory Kit

**TAK030** – (4) Network patch cables 12", (2) RJ45 to 8 way alligator clips, (2) F-Jack to BNC adaptor, (2) RJ45 Port Savers



**Cable Assembly, 24", 8-Way Alligator Clips to RJ45**  
TCA015



**Network Patch Cable, 12" Cat5e FTP, (2) TCA016**



**Network Patch Cables, 5" Cat6 FTP (4) 610025C**





## Tester Accessories: (continued)

**Hanging Pouch 4007**



**Large Shoulder Bag 4008**



**Power Supply for Net Chaser**

**TPS120** – AC to DC power supply: 12V 2.5A, includes NA/EU/AU/UK plug adapters



**Cable Tester Belt Pouch 4003PT**

For MapMaster 2.0, LANSeeker, and 4MAPPER



**Hanging Strap with Carabineer Clip**

**TAK010** – For Cable Prowler, Net Prowler, and Net Chaser



**Prowler Kickstand**

**TAK020** – For Cable Prowler and Net Prowler



## Protective Cases

4060



4068



4076



Part #	Description	
4060	Durable Plastic Case for VDV MapMaster 2.0	See Page 74
4068	Durable Plastic Case for Cable Prowler and Net Prowler	See Pages 68-70
4076	Net Chaser Protective Case	See Pages 66-67

## Cable Tester Smart Remote Kit

Maximize efficiency and save time by eliminating the need to walk back and forth to test sites. Combine this kit with your tester to both test and Map/ID up to eight drops/locations simultaneously. Smart Remotes are a smarter way to go!

### Features

- Test and Map/ID voice/data simultaneously
- Cat7, Cat6A, Cat6, Cat5e, and Cat5 cables
- Shielded and unshielded cables
- Works on UTP/FTP cables

Part #	Description
T138	Cable Tester Smart Remote, #1-8, Case
T139	Cable Tester Smart Remote, #2-8, Case



T138

**Combine a Smart Remote Kit with these testers**

- VDV MapMaster 2.0, P/N T129 – See Page 74
- VDV MapMaster 3.0, P/N T130 – See Page 72
- Cable Prowler, P/N TCB300 – See Page 70
- Net Prowler, P/N TNP700 – See Page 68
- Net Chaser, P/N TCN950AR – See Page 66

Patch Cables Not Included

# Kits

## EXO™ ezEX-RJ45® Termination Kit

The EXO ezEX-RJ45 Termination System is the perfect mix of tools for new or experienced installers. You don't want to leave home without these essential tools. This kit includes electrician scissors, cable jacket stripper, EXO Crimp Frame, EXO-EX Die, and 10 ezEX44 RJ45 connectors. All tools and connectors come neatly organized in the Platinum Tools heavy-duty nylon zippered case.



### 90140

#### Kit Includes:

- EXO Crimp Frame with EXO-EX Die
- ezEX44 ezEX-RJ45 Connectors (10)
- Cat5e/6 Cable Jacket Stripper
- Professional Electrician's Scissors
- Nylon Zippered Case, w/ Handles

Part #	Description
--------	-------------

90140	EXO™ ezEX-RJ45® Termination Kit
-------	---------------------------------

*See page 45  
for additional  
ezEX-RJ45 Connectors*

## EXO™ EZ-RJ45® Termination Kit

The EXO EZ-RJ45 Termination System allows the user to prepare and terminate with precision and speed. This kit includes electrician scissors, cable jacket stripper, EXO Crimp Frame, EZ-RJ45 Die, and 10 EZ-RJ45 Cat5E connectors. All tools and connectors come neatly organized in the Platinum Tools heavy-duty nylon zippered case.



### 90141

#### Kit Includes:

- EXO Crimp Frame with EZ-RJ45 Die
- EZ-RJ45 Cat5e Connectors (10)
- Cat5e/6 Cable Jacket Stripper
- Professional Electrician's Scissors
- Nylon Zippered Case, w/ Handles

Part #	Description
--------	-------------

90141	EXO™ EZ-RJ45® Termination Kit
-------	-------------------------------

*See page 46  
for additional  
EZ-RJ45 Connectors*

### EXO™ ezEX-RJ45® Termination & Test Kit

The EXO ezEX-RJ45 Termination & Test Kit is an all-in-one kit for the tools and test equipment needed for precision and speed in the field. This kit includes all the termination, preparation, and test tools needed to properly terminate ezEX44 connectors. All tools, tester, and connectors come neatly organized in the Platinum Tools heavy-duty nylon hanging tool pouch.

#### 90148

**Kit Includes:**

- EXO Crimp Frame with EXO-EX Die
- ezEX44 ezEX-RJ45 Connectors (30)
- LANSeeker Cable Tester
- Cat5e/6 Cable Jacket Stripper
- Professional Electrician's Scissors
- Hanging Pouch

**Part # Description**

**90148 EXO™ ezEX-RJ45® Termination & Test Kit**



See page 45-46

for additional  
ezEX-RJ45 and EZ-RJ45  
Connectors

### EXO™ Deluxe Termination & Test Kit

The EXO Deluxe Termination & Test Kit is the perfect one stop cable preparation, termination, and test kit. This kit includes all the termination, preparation, and test tools needed to properly terminate EZ-RJ45, ezEX44, and ezEX48 connectors. With this kit, you will be able to terminate various cable sizes and conductor diameters with precision and test for proper termination. All tools and connectors come neatly organized in the Platinum Tools heavy-duty nylon Big Mouth Tool Bag.

#### 90149

**Kit Includes:**

- EXO Crimp Frame with EXO-EX Die
- EZ-RJ45 Die for EXO Crimp Frame
- ezEX44 ezEX-RJ45 Connectors (100)
- ezEX48 ezEX-RJ45 Connectors (100)
- EZ-RJ45 Cat5e Connectors (100)
- EZ-RJ45 Cat6 Connectors (100)
- LANSeeker Cable Tester
- CCS-6 Cable Cutter
- Cyclops 2 Cable Jacket Stripper
- 5" Scissor-Run Electrician's Scissors
- Big Mouth Tool Bag

**Part # Description**

**90149 EXO™ Deluxe Termination & Test Kit**



## 10Gig Termination Kit

Streaming media demands robust, dependable networks, including 10Gig Cat6A shielded cable, to provide the necessary expanded bandwidth. However, these larger, shielded cables require special connectors and tools.

Our 10Gig shielded connector and Tele-TitanXg crimp tool are specifically designed to terminate Cat6A cables. A pairing that assures you will achieve 10Gig performance... a true 10Gig Termination System.

### 90170

#### Kit Includes:

- Tele-TitanXg Crimp Tool
- Cyclops 2 Cable Jacket Stripper
- CT-360 External Ground Crimp Tool
- RJ45 Cat6A 10Gig Shielded Connector w/Liners (100)

#### Part # Description

90170	10Gig Termination Kit
-------	-----------------------

#### Application:

- Cat6E
- Cat6A 10Gig
- Cat7
- Over-sized Cat5e/6 Industrial Ethernet Cables



### Tele-TitanXg Crimp Tool

- Specifically made for terminating Platinum's RJ45 Cat6A 10Gig Shielded Connectors (Not for standard RJ45 modular plugs)
- Straight action vertical crimp force
- Minimum hand force for a perfect crimp

## Tele-TitanXg™

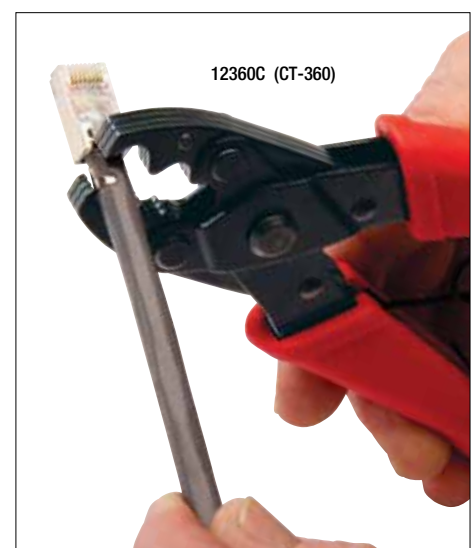
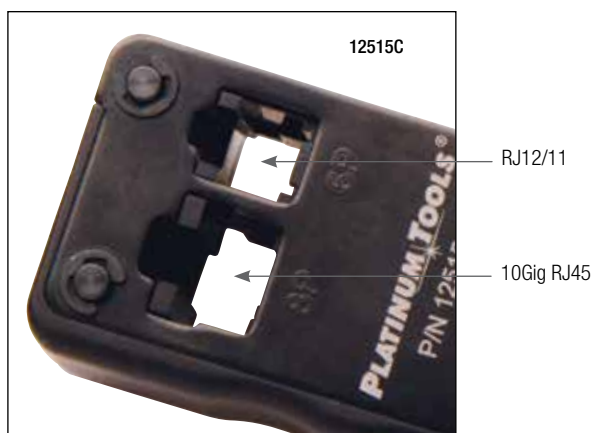

106190 (terminated)

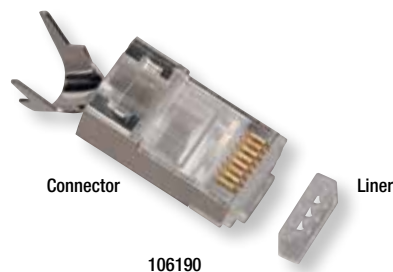
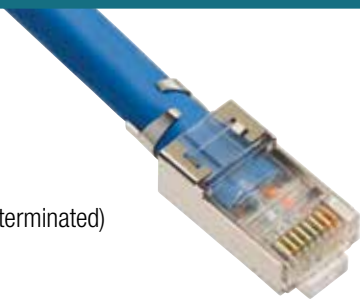

Connector

Liner

106190

**RJ45 Cat6A 10Gig Shielded Connector:**

- Max cable OD: 0.335" (8.5mm)
- Max conductor OD: 0.053" (1.35mm)
- Meets 10Gig performance standard
- UL and RoHS compliant



**Cyclops 2 Cable Jacket Stripper**

- Self-adjusts to automatically score PVC and Plenum
- Ready-to-use out of the kit
- Works with shielded/unshielded twisted pair and fiber optic cables
- Accepts cable ODs 0.10" to 0.43" (2.5mm – 11mm)

**CT-360 External Ground Crimp Tool**

- 360° crimp on the external ground tab of shielded RJ45 connectors
- Perform concentric termination with full control to prevent over or under crimping
- Dual cavity covers wide range of cable ODs ranging from 0.245" to 0.335" (6.2mm – 8.5mm)
- Spring-loaded, non-ratcheted design
- Steel frame, black oxide finish, molded handles

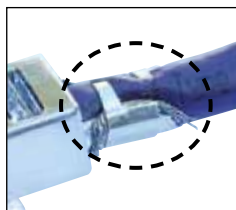

Crimped External Ground



15010C

## 90203

### Kit Includes:

- Coax & Round Wire Cable Cutter
- Cat5e/6 Cable Jacket Stripper
- All-In-One Modular Plug Crimp Tool (Ratcheted)
- 6-in-1 Screwdriver
- RJ45 (8P8C) Cat5e Modular Plug, 3-Prong, Solid Wire (25)
- Nylon Zippered Case



### Part # Description

90203 Premier Data Connectivity Kit

## Premier Data Connectivity Kit

Platinum Tools' Premier Series Kits deliver a practical solution and offer the right mix of products that will withstand even the toughest jobs. The Premier Data Connectivity Kit provides the essential tools and connectors required for data network installations.



## Twisted Pair Termination Kit

Featuring the patented EZ-RJ45 system, this kit includes all the tools required for data communications and telephone installations using twisted pair cable.



## 90122

### Kit Includes:

- BTP-6 Coax and Data Cable Cutter
- Cat5e/6 Cable Jacket Stripper
- EZ-RJ45 Crimp Tool
- PT Punchdown Tool
- NEVERDull 110 Punchdown Blade
- EZ-RJ45 Cat5e Connector (10)
- Nylon Zippered Case

### Part # Description

90122 Twisted Pair Termination Kit

## EZ-RJ45® Convenience Packs

Assembled for the installer who needs the complete EZ-RJ45 system to add to their existing tool bag; packaged to fit your budget with your choice of the original EZ-RJ45 or the EZ-RJPRO HD Crimp Tool and EZ-RJ45 Cat5e Connectors. All kits include detailed instructions.



EZ-RJPRO HD Crimp Tool  
100054C



EZ-RJ45 Crimp Tool  
100004C



EZ-RJ45 Cat5e Connector  
105003

Part #	Description	EZ-RJPRO HD Crimp Tool 100054C	EZ-RJ45 Crimp Tool 100004C	EZ-RJ45 Cat5e Connector 105003
100007	EZ-RJPRO™ HD Convenience Pack	■		50
100002	EZ-RJ45® Convenience Pack - 200		■	200
100005	EZ-RJ45® Convenience Pack - 50		■	50
100008*	EZ-RJ45® Combo - 24		■	24

\* Packaged in clamshell.

### EZ-RJPRO™ Termination Pod

Twisted pair made EZ. Professional, modular plug cable prep, and termination kit for Cat3, Cat5, Cat5e, or Cat6 compliant data networks.

#### 90173

**Kit Includes:**

- EZ-RJPRO HD Crimp Tool
- Cat5e/6 Cable Jacket Stripper
- Electrician's Scissors, 5"
- EZ-RJ45 Cat5e Connector (100)
- EZ-RJ45 Cat6 Connector (100)
- EZ-RJ12/11 Connector (50)

**Part # Description**

**90173 EZ-RJPRO™ Termination Pod**



**For Additional Information:**

- *EZ-RJPRO HD Crimp Tool* – Crimper section, page 18
- *Cat5e/6 Cable Jacket Stripper* – Stripper section, page 13
- *Electrician's Scissors* – Cutter section, page 2
- *EZ-Connectors* – Connector section, pages 46-47

### EZ-RJ45® Basic Installation Kit Bundles

In addition to the EZ-RJ45 or EZ-RJPRO HD Crimp Tool and connectors, the Kit Bundles also include other cable preparation tools you will need to complete your job. All kits include detailed instructions.



#### 100012

**Kit Includes:**

- Coax & Round Wire Cable Cutter
- Cat5e/6 Cable Jacket Stripper
- EZ-RJ45 Crimp Tool
- EZ-RJ45 Cat5e Connector (50)

**Part # Description**

**100012 EZ-RJ45® Basic Installation Kit Bundle**



Cat5e/6 Cable Jacket Stripper 15015C Pg. 13



EZ-RJ45 Cat5e Connectors Pgs. 46-47



EZ-RJPRO HD Crimp Tool 100054C - Pg. 18



EZ-RJ45 Crimp Tool 100004C - Pg. 18



Coax & Round Wire Cable Cutter 10500C - Pg. 4

#### 100016

**Kit Includes:**

- Coax & Round Wire Cable Cutter
- Cat5e/6 Cable Jacket Stripper
- EZ-RJPRO HD Crimp Tool
- EZ-RJ45 Cat5e Connector (50)

**Part # Description**

**100016 EZ-RJPRO® HD Basic Installation Kit Bundle**

## EZ-RJ45® Termination Kit

This termination kit features the patented EZ-RJ45 Crimp Tool and Connectors coupled with snips and a nick-free UTP/STP stripper, for the simplest, fastest, and highest performing installation of Cat5/5e/6 data networks.

### 90136

#### Kit Includes:

- Professional Electrician's Scissors
- Cat5e/6 Cable Jacket Stripper
- EZ-RJ45 Crimp Tool
- EZ-RJ45 Cat5e Connector (10)
- Nylon Zippered Case

Part #	Description
90136	EZ-RJ45® Termination Kit



## EZ-RJPRO™ HD Termination Kit

Designed for installers working with high-performance, larger OD cables. Includes the patented EZ-RJPRO HD Crimp Tool, EZ Connectors, and required tools to tackle those harder to terminate cables.



### 90151

#### Kit Includes:

- Professional Electrician's Scissors
- Cat5e/6 Cable Jacket Stripper
- EZ-RJPRO HD Crimp Tool
- EZ-RJ45 Cat5e Connector (10)
- Nylon Zippered Case, w/Handles

Part #	Description
90151	EZ-RJPRO® HD Termination Kit

## PRO Punchdown Kit

Keeps your tools readily accessible and organized so you're always ready to perform those datacom jobs. This tool pouch kit will quickly become part of your daily gear.



### 90152C

#### Kit Includes:

- Professional Electrician's Scissors
- PT Punchdown Tool
- NEVERDull 110 Punchdown Blade
- Punchdown Tool Pouch
- Black Fine Tip Sharpie® Pen

Part #	Description
90152C	PRO Punchdown Kit



### Basic Twisted Pair and Coax Kit

Featuring the patented EZ-RJ45 Crimp Tool and Connectors for simple, high performance Cat5/5e data networks. This kit provides the basic tools required for data, telephone, and CATV structured wire installations.



### 90121

**Kit Includes:**

- Coax and Round Wire Cable Cutter
- Coax Cable Stripper, 2-Level RG58/59/62/6/6Q
- Cat5e/6 Cable Jacket Stripper
- EZ-RJ45 Crimp Tool
- PT Punchdown Tool
- NEVERDull110 Punchdown Blade
- F Connector 8" Assembly/Removal Tool
- EZ-RJ45 Cat5e Connector (10)
- Nylon Zippered Case

Part #	Description
--------	-------------

90121	Basic Twisted Pair and Coax Kit
-------	---------------------------------

### PRO Twisted Pair and Coax Termination Kit

Terminate RJ45 or RJ12/11 and F, BNC, or RCA connectors with ease. This kit features the patented EZ-RJ45 Crimp Tool and SealSmart Compression Tool along with the other necessary tools to cut, strip, and terminate twisted pair and coaxial cables.



### 90124

**Kit Includes:**

- Coax and Round Wire Cable Cutter
- Coax Cable Stripper, 2-Level RG58/59/62/6/6Q
- Cat5e/6 Cable Jacket Stripper
- SealSmart Compression Crimp Tool
- EZ-RJ45 Crimp Tool
- PT Punchdown Tool
- NEVERDull 110 Punchdown Blade
- F Connector 8" Assembly/Removal Tool
- Nylon Zippered Case

Part #	Description
--------	-------------

90124	PRO Twisted Pair and Coax Termination Kit
-------	---

### Basic HD Twisted Pair and Coax Kit

Provides the basic tools required for data, telephone, and coax structured wiring installations. Features the patented EZ-RJPRO HD Crimp Tool.



### 90150

**Kit Includes:**

- Coax and Round Wire Cable Cutter
- Coax Cable Stripper, 2-Level RG58/59/62/6/6Q
- Cat5e/6 Cable Jacket Stripper
- EZ-RJPRO HD Crimp Tool
- PT Punchdown Tool
- NEVERDull 110 Punchdown Blade
- 6-in-1 Screwdriver
- EZ-RJ45 Cat5e Connector (10)
- Nylon Zippered Case, w/Handles

Part #	Description
--------	-------------

90150	Basic HD Twisted Pair and Coax Kit
-------	------------------------------------

## PRO HD Twisted Pair and Coaxial Kit

Includes our most versatile and rugged wire and cable preparation tools so you can quickly and effortlessly tackle your data, voice, and video projects on time and on budget.



## 90153

### Kit Includes:

- Coax and Round Wire Cable Cutter
- ProStrip 25R Coax Stripper
- Cat5e/6 Cable Jacket Stripper
- SealSmart Compression Crimp Tool
- EZ-RJPRO HD Crimp Tool
- PT Punchdown Tool
- NEVERDull 110 Punchdown Blade
- F Connector 8" Assembly/Removal Tool
- Nylon Zippered Case, w/Handles

### Part # Description

90153 PRO HD Twisted Pair and Coaxial Kit

## 90201

### Kit Includes:

- Coax and Round Wire Cable Cutter
- Double-Ended Coax Stripper – RG7/11/213 and RG59/6/6Q
- SealSmart II Compression Crimp Tool
- F Connector 8" Assembly/Removal Tool
- SealSmart F Connectors for RG 6 Cable (10)
- Nylon Zippered Case

### Part # Description

90201 Premier CATV Connectivity Kit

## Premier CATV Connectivity Kit

Platinum Tools' Premier Series Kits deliver a practical solution and offer the right mix of products that will withstand even the toughest jobs. The Premier CATV Connectivity Kit provides the essential tools and connectors required for CATV F cable runs.



## Premier CCTV Connectivity Kit

Platinum Tools' Premier Series Kits deliver a practical solution and offer the right mix of products that will withstand even the toughest jobs. The Premier CCTV Connectivity Kit includes rugged and easy to use tools carefully selected to make you more productive and ensure that terminations are done right, the first time.



## 90202

### Kit Includes:

- Coax & Round Wire Cable Cutter
- Double-Ended Coax Stripper – RG7/11/213 & RG59/6/6Q
- SealSmart II Compression Crimp Tool
- 6-in-1 Screwdriver
- SealSmart BNC Connectors for RG59 Cable (8)
- Nylon Zippered Case

### Part # Description

90202 Premier CCTV Connectivity Kit

### SealSmart™ Field Installation Kits

If your job requires you to use compression F, RCA, and BNC connectors in assorted cables sizes and you have been trying to figure out how to keep it all organized, the SealSmart Field Installation Kits provide the ultimate solution. Store your tools and connectors in a rugged, high impact plastic case with compartments to assist in identifying, sorting, and re-stocking all components quickly and easily. Available with nickel or gold plated connectors.

#### 90126

**Kit Includes:**

- |  | <b>Qty</b> |
|--|------------|
| • Coax Cable Stripper, 2-Level RG58/59/62/6/6Q | 1          |
| • SealSmart Compression Crimp Tool             | 1          |
| • SealSmart F Connectors for RG6 Quad Cable    | 20         |
| • SealSmart F Connectors for RG6 Cable         | 20         |
| • SealSmart F Connectors for RG59 Cable        | 20         |
| • SealSmart BNC Connectors for RG6 Quad Cable  | 10         |
| • SealSmart BNC Connectors for RG6 Cable       | 10         |
| • SealSmart BNC Connectors for RG59 Cable      | 10         |
| • SealSmart RCA Connectors for RG6 Quad Cable  | 10         |
| • SealSmart RCA Connectors for RG6 Cable       | 10         |
| • SealSmart RCA Connectors for RG59 Cable      | 10         |
| • SealSmart Compartmented Plastic Case         | 1          |

**Part # Description**

**90126 SealSmart™ Field Installation Kit, Gold**

#### 90125

**Kit Includes:**

- |  | <b>Qty</b> |
|--|------------|
| • Coax Cable Stripper, 2-Level RG58/59/62/6/6Q | 1          |
| • SealSmart Compression Crimp Tool             | 1          |
| • SealSmart F Connectors for RG6 Quad Cable    | 20         |
| • SealSmart F Connectors for RG6 Cable         | 20         |
| • SealSmart F Connectors for RG59 Cable        | 20         |
| • SealSmart BNC Connectors for RG6 Quad Cable  | 10         |
| • SealSmart BNC Connectors for RG6 Cable       | 10         |
| • SealSmart BNC Connectors for RG59 Cable      | 10         |
| • SealSmart RCA Connectors for RG6 Quad Cable  | 10         |
| • SealSmart RCA Connectors for RG6 Cable       | 10         |
| • SealSmart RCA Connectors for RG59 Cable      | 10         |
| • SealSmart Compartmented Plastic Case         | 1          |

**Part # Description**

**90125 SealSmart™ Field Installation Kit, Nickel**



### 22-in-1 Security Screwdriver Kit

The perfect set for security installers – reach into those deep crevices with ease and never be without the right screwdriver. It features a non-slip, comfort grip handle with a high impact plastic core and 11 double sided security shaft style bits. The shaft style bits enable access into recessed screws up to 5" deep. The bit load includes multiple sizes of Security Torx, Hex, and Robertson along with Spanners and Tri-Wings so the list of applications are endless. In addition to the security applications, this kit can be used on standard hex and torx screws and includes a slotted and Phillips head bit for traditional screwdriver applications.

**19105 Bit Load:**

- **Security Torx®:** T8, T10, T15, T20
- **Security Hex:** 1/8", 9/64", 5/32", 3/16"  
2.5mm, 3mm, 4mm, 5.5mm
- **Spanner:** 4, 6, 8, 10
- **Security Robertson:** 1, 2
- **Tri-Wings:** 2, 3
- **Slotted:** 7/32" **Phillips:** #2

**Part # Description**

**19105 22-in-1 Security Screwdriver Kit**



Part #	Description	Page
600WH-25	Standard 1 Gang Blank, White	54
601LA-25	Standard Wall Plate 1 Port, Light Almond (25)	54
601WH-25	Standard Wall Plate 1 Port, White (25)	54
602LA-25	Standard Wall Plate 2 Port, Light Almond (25)	54
602WH-25	Standard Wall Plate 2 Port, White (25)	54
604LA-25	Standard Wall Plate 4 Port, Light Almond (25)	54
604WH-25	Standard Wall Plate 4 Port, White (25)	54
6070K1	Replacement Cord Set Kit, (RECON Butt Set/Test Set)	76, 77
610025C	Network Patch Cables, 5" Cat6 FTP	86
610030	FTP Patch Cable, 5" CAT6	86
650-12C5	12 Port Cat5e Non-Shielded Patch Panel	56-57
651-24C5	24 Port Cat5e Non-Shielded Patch Panel	56, 58
660-12C6	12 Port Cat6 Non-Shielded Patch Panel	56-57
661-24C6	24 Port Cat6 Non-Shielded Patch Panel	56, 58
667-12C6S	12 Port Cat6 Shielded Patch Panel	56
668-24C6S	24 Port Cat6 Shielded Patch Panel	56, 59
675-24C6AS	24 Port Cat6A Shielded Patch Panel	56, 59
705BK-1	EZ-SnapJack, Cat5e, Black (Bulk)	55
705BK-40	EZ-SnapJack, Cat5e, Black (40)	55
705BK-4C	EZ-SnapJack, Cat5e, Black (4)	55
705BL-1	EZ-SnapJack, Cat5e, Blue (Bulk)	55
705BL-20J	EZ-SnapJack, Cat5e, Blue (20)	55
705BL-40	EZ-SnapJack, Cat5e, Blue (40)	55
705BL-4C	EZ-SnapJack, Cat5e, Blue (4)	55
705IV-1	EZ-SnapJack, Cat5e, Ivory (Bulk)	55
705IV-40	EZ-SnapJack, Cat5e, Ivory (40)	55
705IV-4C	EZ-SnapJack, Cat5e, Ivory (4)	55
705LA-1	EZ-SnapJack, Cat5e, Light Almond (Bulk)	55
705LA-40	EZ-SnapJack, Cat5e, Light Almond (40)	55
705LA-4C	EZ-SnapJack, Cat5e, Light Almond (4)	55
705OR-1	EZ-SnapJack, Cat5e, Orange (Bulk)	55
705OR-40	EZ-SnapJack, Cat5e, Orange (40)	55
705OR-4C	EZ-SnapJack, Cat5e, Orange (4)	55
705WH-1	EZ-SnapJack, Cat5e, White (Bulk)	55
705WH-20J	EZ-SnapJack, Cat5e, White (20)	55
705WH-40	EZ-SnapJack, Cat5e, White (40)	55
705WH-4C	EZ-SnapJack, Cat5e, White (4)	55
705YL-1	EZ-SnapJack, Cat5e, Yellow (Bulk)	55
705YL-40	EZ-SnapJack, Cat5e, Yellow (40)	55
705YL-4C	EZ-SnapJack, Cat5e, Yellow (4)	55
706BK-1	EZ-SnapJack, Cat6, Black (Bulk)	55
706BK-40	EZ-SnapJack, Cat6, Black (40)	55
706BK-4C	EZ-SnapJack, Cat6, Black (4)	55
706BL-1	EZ-SnapJack, Cat6, Blue (Bulk)	55
706BL-40	EZ-SnapJack, Cat6, Blue (40)	55
706BL-4C	EZ-SnapJack, Cat6, Blue (4)	55
706IV-1	EZ-SnapJack, Cat6, Ivory (Bulk)	55
706IV-40	EZ-SnapJack, Cat6, Ivory (40)	55
706IV-4C	EZ-SnapJack, Cat6, Ivory (4)	55
706LA-1	EZ-SnapJack, Cat6, Light Almond (Bulk)	55
706LA-40	EZ-SnapJack, Cat6, Light Almond (40)	55
706LA-4C	EZ-SnapJack, Cat6, Light Almond (4)	55
706OR-1	EZ-SnapJack, Cat6, Orange (Bulk)	55
706OR-40	EZ-SnapJack, Cat6, Orange (40)	55
706OR-4C	EZ-SnapJack, Cat6, Orange (4)	55
706WH-1	EZ-SnapJack, Cat6, White (Bulk)	55
706WH-40	EZ-SnapJack, Cat6, White (40)	55
706WH-4C	EZ-SnapJack, Cat6, White (4)	55
706YL-1	EZ-SnapJack, Cat6, Yellow (Bulk)	55
706YL-40	EZ-SnapJack, Cat6, Yellow (40)	55
706YL-4C	EZ-SnapJack, Cat6, Yellow (4)	55
723LA-50	Keystone Cat3, 6 Pin, 110 Jack, Light Almond (50)	52
723WH-50	Keystone Cat3, 6 Pin, 110 Jack, White (50)	52
725BL-50	Keystone Cat5e, 110 Jack, Blue (50)	52
725LA-50	Keystone Cat5e, 110 Jack, Light Almond (50)	52
725WH-50	Keystone Cat5e, 110 Jack, White (50)	52
726BL-50	Keystone Cat6, 110 Jack, Blue (50)	52
726LA-50	Keystone Cat6, 110 Jack, Light Almond (50)	52
726WH-50	Keystone Cat6, 110 Jack, White (50)	52
751-1	Keystone Cat6A, Tool-less, Shielded Jack (1)	53
752BL-1	Keystone Cat6A, Tool-less, UTP Jack, Blue (1)	52
752WH-1	Keystone Cat6A, Tool-less, UTP Jack, White (1)	52
765WH-10	Keystone Cat5e Data Coupler, White (10)	53
775WH-1C	HDMI-to-HDMI Pigtail, White	53
780LA-50	Keystone F – 36GHz, Light Almond	52
780WH-50	Keystone F – 36GHz, White	52
790LA-10	Keystone Blank Insert, Light Almond (10)	52
790WH-10	Keystone Blank Insert, White (10)	52
1081	Fixed Handle Cutting Boot	7
4003PT	Cable Tester Belt Pouch	76, 87
4007	Hanging Pouch	75, 87
4008	Large Shoulder Bag	87
4015C	Punchdown Tool Pouch	30, 94
4060	Durable Plastic Case (for VDV MapMaster 2.0)	87
4068	Durable Plastic Case (for Cable Prowler and New Prowler)	87
4076	Net Chaser Protective Case	67, 87
6050	Replacement Blade for P/N 10565	7
6051	Replacement Blade for P/N 10560	7
6055	Replacement Blade for P/N 10569C	6
6070K1	Replacement Cord Set Kit	75
10005C	Cable Jacket Slitter (0.18-1.0")	9
10006C	Replacement Blade for Slitters	9
10007C	Cable Jacket Slitter (1-1.4")	9
10017C	TOR Cable Jacket Stripper and Slitter	8
10018C	TOR Replacement Blade	8
10200C	Heavy Duty Cable Tie Gun	33
10500C	Coax & Round Wire Cable Cutter	4
10503	Cut-N-Strip	3
10510C	BTP-6 Coax & Data Cable Cutter	4
10512C	Steel Wire Cutter	5
10513C	Wire Rope Cutter	6
10514C	CCS-6 Cable Cutter	5
10517C	Scissor-Run Electrician's Scissors	2
10519C	Leather Pouch & Cable Splicer's Knife	2
10520C	Cable Splicer's Knife	2
10521C	Leather Pouch	2
10522C	Scissor-Run Electrician's Scissors Kit	2
10525C	Professional Electrician's Scissors	2
10526C	Professional Electrician's Scissors Kit	2
10529C	Kevlar Fiber Optic Scissors	3
10530C	Ceramic Kevlar Scissors	3
10531C	5" Side Cutting Pliers	4
10540C	BTC-20 Cable Cutter	5
10550C	100 Pair Cable Cutter	6
10560	Ratcheted Telcom Cutter – 2,700 Pair	7
10565	Ratcheted Utility Cutter – 750 MCM	7
10569C	500 MCM Cable Cutter	6
10711C	PRO Drywall Saw	34
11000R	BNC 12" Removal Tool	34
11001	BNC 18" Removal Tool	34
11006	BNC 8" Removal Tool	34
11008	BNC 8" Economy Removal Tool	35
11009	BNC 12" Economy Removal Tool	35
11020	F Connector 12" Removal Tool	35
11021	F Connector 8" Removal Tool	35
11022	F Connector 15.5" Removal Tool	35
11050	1.0/2.3 Connector Removal Tool	34

12100C	Connector Pressing Telecom Pliers	33
12101C	7" Long Nose Crimping Pliers	32
12102C	6" Long Nose Telcom Pliers	32
12103C	6" Telcom Diagonal Cutting Pliers	32
12150C	Terminal Crimp Tool	26
12201C	8.5" Lineman's Pliers	32
12206C	6" Lineman's Pliers	32
12360C	External Ground Crimp Tool	20
12503BLC	Replacement Blade Set for P/N 12503C	21
12503C	All-in-One Modular Plug Crimp Tool	21
12507BLC	Replacement Blade Set for P/N 12507C and 12515C	19, 21
12507C	Tele-Titan Modular Plug Crimp Tool	21
12508C	TeleTitan Combo Pack	21
12515C	Tele-TitanXg Crimp Tool	19
12516C	Tele-TitanXg 2.0 Crimp Tool	20
12517C	Tele-TitanXg 2.0 Combo 10-Pack	20
13003C	Punchdown Blade, 630	29
13004BLC	Replacement Knives for P/N 13004C	29, 31
13004C	110 EZ-Data Cut Blade	29
13010C	4-Way, 8 Point Indent Crimp Tool	27
13015C	4-Way, 12 Point Indent Crimp Tool	27
13022C	Punchdown Extension Tool	29
13023C	Punchdown Blade, BIX	29
13024C	Punchdown Blade, Krone	29
13031C	Punchdown Blade, NEVERDull 66/110 Style	29
13032C	Punchdown Blade, NEVERDull 110 Style	29
13033C	Punchdown Blade, NEVERDull 66 Style	29
13150C	PRO-Strike Punchdown Tool, Handle Only	28
13155C	PRO-Strike Punchdown Tool, w/NEVERDull 66 Blade	28
13156C	PRO-Strike Punchdown Tool, w/NEVERDull 110 Blade	28
13157C	PRO-Strike Punchdown Tool, w/NEVERDull 66 & 110 Blades	28
13159C	PRO-Strike Punchdown Tool, w/NEVERDull 66/110 Combo Blade	28
13300C	Punchdown Tool, handle only	30
13305C	Punchdown Tool, w/NEVERDull 66 blade	30
13306B	Punchdown Tool, w/NEVERDull 110 blade	30
13307B	Punchdown Tool, w/NEVERDull 66 & 110 blade	30
13309B	Punchdown Tool, w/NEVERDull 66/110 Combo blade	30
13501C	Xpress Jack w/Platinum Tools Die	31
13511C	Xpress Jack Platinum Tools Die	31
13552C	Xpress Jack Leviton Die	31
15001C	V-Notch Adjustable Wire Stripper	12
15003C	ProStrip 10/20 Wire Stripper	11
15005C	ProStrip 16/30 Wire Stripper	11
15010C	Cyclops 2 Cable Jacket Stripper	13
15015C	Cat5e/6 Cable Jacket Stripper	13
15020C	Double Ended Coax Stripper	14
15021C	SealSmart Coax Stripper – RG6 Quad	14
15022C	SealSmart Coax Stripper – RG6	14
15023C	SealSmart Coax Stripper – RG59	14
15024C	SealSmart Coax Stripper – Mini RG59	14
15028C	ProStrip 25R Coax Stripper	15
15029C	Replacement Blade Cartridge for P/N 15028C	15
15030C	Coax Stripper – 2 Level, RG58/59/62/6/6Q	15
15031C	Coax Stripper – 2 Level, RG58/59/62	15
15032C	Coax Stripper – 2 Level, RG59/62/6	15
15033C	Coax Stripper – 3 Level, RG58/59/62	15
15034C	Coax Stripper – 3 Level, RG59/62/6/6Q	15
15035C	Coax Stripper – 3 Level, RG7/8/11/213/214	15
15038C	Replacement Blade (2) for 2 Level Strippers	15
15039C	Replacement Blade (2) for 3 Level Strippers	15
15041C	BR1 Multi-Stripper	13
15041BLC	BR1 Blade Set	13
15042C	Replacement Blade Cassette for BR1	13
15060C	Adjustable Fiber Optic Stripper	12

15061C	5-in-1 Fiber Optic Stripper	12
15305C	Minim 2.5 Self Adjusting Wire Stripper	11
15308	Replacement Blade Cassette for Minim	11
15310C	Maxim 6 Self Adjusting Wire Stripper	10
15313	Replacement Blade Cassette for Maxim 6	10
15316	Maxim 16 Self Adjusting Wire Stripper	10
15317	Replacement Blade Cassette for Maxim 16	10
16000C	8" Crimp Tool Only	26
16001C	8" Crimp Tool w/Die Set P/N 16051C	26
16003C	8" Crimp Tool w/Die Set P/N 16053C	26
16004C	8" Crimp Tool w/Die Set P/N 16054C	26
16005C	8" Crimp Tool w/Die Set P/N 16055C	26
16006C	8" Crimp Tool w/Die Set P/N 16056C	26
16007C	8" Crimp Tool w/Die Set P/N 16057C	26
16051C	Die Set – Fiber Optics SMA, ST, SC, FC	26
16053C	Die Set – Fiber Optics SMA, ST, SC	26
16054C	Die Set – Open Barrel Contacts	26
16055C	Die Set – Open Barrel D-Sub & RS232	26
16056C	Die Set – Open Barrel Pin & Socket	26
16057C	Die Set – DIN & US Wire Ferrules	26
16201C	SealSmart Compression Crimp Tool	22
16202C	SealSmart BNC Adapter & Nut	22
16203C	SealSmart F Adapter & Nut	22
16204C	SealSmart RCA Adapter & Nut	22
16207C	F Compression Crimp Tool	22
16212C	RH360L F Compression Tool-Long Stroke	23
16213C	PROCON Crimp Tool	23
16214C	RH360S F Compression Tool -Short Stroke	23
16215C	Replacement Multi-Head Adapter for P/N 16213C	23
16220C	SealSmart II Compression Crimp Tool	22
16500C	9" Ergo Crimp Tool	24
16501C	9" Ergo Crimp Tool w/Die Set P/N 17051C	25
16502C	9" Ergo Crimp Tool w/Die Set P/N 17052C	25
16503C	9" Ergo Crimp Tool w/Die Set P/N 17053C	25
16504C	9" Ergo Crimp Tool w/Die Set P/N 17054C	25
16505C	9" Ergo Crimp Tool w/Die Set P/N 17055C	25
16506C	9" Ergo Crimp Tool w/Die Set P/N 17056C	25
16507C	9" Ergo Crimp Tool w/Die Set P/N 17057C	25
16508C	9" Ergo Crimp Tool w/Die Set P/N 17058C	25
16509C	9" Ergo Crimp Tool w/Die Set P/N 17059C	25
16510C	9" Ergo Crimp Tool w/Die Set P/N 17060C	25
16511C	9" Ergo Crimp Tool w/Die Set P/N 17061C	25
16512C	9" Ergo Crimp Tool w/Die Set P/N 17062C	25
16801C	Open Barrel Crimp Tool	27
17051C	Die Set – Heavy Duty Insulated Terminals	25
17052C	Die Set – Non-Insulated Terminals	25
17053C	Die Set – Coax BNC/TNC/HDTV	25
17054C	Die Set – Coax BNC/TNC 3 Piece	25
17055C	Die Set – CATV F Type Connectors	25
17056C	Die Set – Coax BNC/TNC F Type Connectors	25
17057C	Die Set – Commercial Insulated Terminals	25
17058C	Die Set – Commercial Open Barrel	25
17059C	Die Set – SMA/SMB/Mini Coax, BNC/TNC	25
17060C	Die Set – N Type Plugs	25
17061C	Die Set – HDTV/True 75 Ohm/BNC/TNC	25
17062C	Die Set – Coax BNC/TNC 2-Piece	25
17099C	Quick Change Die Screws (2)	24
18001	SealSmart F Conns, RG6Q, Ni Plate (100)	40
18001RA	SealSmart F RA Conns, RG6Q, Ni Plate (25)	40
18002	SealSmart F Conns, RG6Q, Ni Plate (10)	40
18003	SealSmart F RA Conns, RG6Q, Ni Plate (3)	40
18004	SealSmart F Conns, RG6Q Gold Plate (100)	40
18005	SealSmart F Conns, RG6Q, Gold Plate (10)	40
18006	SealSmart F Conns, RG6, Ni Plate (100)	40

18006RA	SealSmart F RA Conns, RG6, Ni Plate (25)	40		
18007	SealSmart F Conns, RG6, Ni Plate (10)	40		
18008	SealSmart F RA Conns, RG6, Ni Plate (3)	40		
18009	SealSmart F Conns, RG6, Gold Plate (100)	40		
18010	SealSmart F Conns, RG6, Gold Plate (10)	40		
18011	SealSmart F Conns, RG59, Ni Plate (100)	40		
18011RA	SealSmart F RA Conns, RG59, Ni Plate (25)	40		
18012	SealSmart F Conns, RG59, Ni Plate (10)	40		
18013	SealSmart F RA Conns, RG59, Ni Plate (3)	40		
18015	SealSmart F Conns, RG59, Gold Plate (100)	40		
18016	SealSmart F Conns, RG59, Gold Plate (10)	40		
18020	SealSmart BNC Conns, RG6Q, Gold Plate (25)	41		
18021	SealSmart BNC Conns, RG6Q, Gold Plate (6)	41		
18025	SealSmart BNC Conns, RG6, Gold Plate (25)	41		
18026	SealSmart BNC Conns, RG6, Gold Plate (6)	41		
18030	SealSmart BNC Conns, RG59, Gold Plate (25)	41		
18031	SealSmart BNC Conns, RG59, Gold Plate (6)	41		
18035	SealSmart BNC Conns, RG6Q, Ni Plate (25)	41		
18035RA	SealSmart BNC RA Conns, RG6Q, Ni Plate (25)	41		
18036	SealSmart BNC Conns, RG6Q, Ni Plate (6)	41		
18037	SealSmart BNC RA Conns, RG6Q, Ni Plate (3)	41		
18038	SealSmart BNC Conns, RG6, Ni Plate (25)	41		
18038RA	SealSmart BNC RA Conns, RG6, Ni Plate (25)	41		
18039	SealSmart BNC Conns, RG6, Ni Plate (6)	41		
18040	SealSmart BNC RA Conns, RG6, Ni Plate (3)	41		
18041	SealSmart BNC Conns, RG59, Ni Plate (25)	41		
18041RA	SealSmart BNC RA Conns, RG59, Ni Plate (40)	41		
18042	SealSmart BNC Conns, RG59, Ni Plate (6)	41		
18043	SealSmart BNC RA Conns, RG59, Ni Plate (3)	41		
18051	SealSmart RCA Conns, RG6, Ni Plate (25)	42		
18051C	SealSmart RCA Conns, RG6, Ni Plate (6)	42		
18051RA	SealSmart RCA RA Conns, RG6, Ni Plate (25)	42		
18052	SealSmart RCA Conns, RG6, Gold Plate (25)	42		
18053	SealSmart RCA Conns, RG6, Gold Plate (6)	42		
18054	SealSmart RCA RA Conns, RG6, Ni Plate (3)	42		
18055	SealSmart RCA Conns, RG59, Gold Plate (25)	42		
18056	SealSmart RCA Conns, RG59, Gold Plate (6)	42		
18057	SealSmart RCA Conns, RG6Q, Gold Plate (25)	42		
18058	SealSmart RCA Conns, RG6Q, Gold Plate (6)	42		
18060	SealSmart RCA Conns, RG59, Ni Plate (25)	42		
18060RA	SealSmart RCA RA Conns, RG59, Ni Plate (25)	42		
18061	SealSmart RCA Conns, RG59, Ni Plate (6)	42		
18062	SealSmart RCA RA Conns, RG59, Ni Plate (3)	42		
18065	SealSmart RCA Conns, RG6Q, Ni Plate (25)	42		
18065RA	SealSmart RCA RA Conns, RG6Q, Ni Plate (25)	42		
18066	SealSmart RCA Conns, RG6Q, Ni Plate (6)	42		
18067	SealSmart RCA RA Conns, RG6Q, Ni Plate (3)	42		
18110	UR Telecom Splice (100)	33, 43		
18112C	UR Telecom Splice (50)	33, 43		
18111	UR Telecom Splice (25)	33, 43		
18120	UY Telecom Splice (100)	33, 43		
18121	UY Telecom Splice (25)	33, 43		
18122C	UY Telecom Splice (100)	33, 43		
18130	UB Telecom Splice (100)	33, 43		
18131	UB Telecom Splice (25)	33, 43		
18132	UB Telecom Splice (100)	33, 43		
18200	SealSmart F Conns, RGB 24 AWG, Ni Plate (25)	40		
18205	SealSmart F Conns, RGB 24 AWG, Gold Plate (25)	40		
18210	SealSmart F Conns, RGB 23 AWG, Ni Plate (25)	40		
18215	SealSmart F Conns, RGB 23 AWG, Gold Plate (25)	40		
18220	SealSmart F Conns, RGB 25 AWG, Ni Plate (25)	40		
18225	SealSmart F Conns, RGB 25 AWG, Gold Plate (25)	40		
18230	SealSmart BNC Conns, RGB 24 AWG, Ni Plate (25)	41		
18235	SealSmart BNC Conns, RGB 24 AWG, Gold Plate (25)	41		
18240	SealSmart BNC Conns, RGB 23 AWG, Ni Plate (25)	41		
18245	SealSmart BNC Conns, RGB 23 AWG, Gold Plate (25)	41		
18250	SealSmart BNC Conns, RGB 25 AWG, Ni Plate (25)	41		
18255	SealSmart BNC Conns, RGB 25 AWG, Gold Plate (25)	41		
18260	SealSmart RCA Conns, RGB 24 AWG, Ni Plate (25)	42		
18265	SealSmart RCA Conns, RGB 24 AWG, Gold Plate (25)	42		
18270	SealSmart RCA Conns, RGB 23 AWG, Ni Plate (25)	42		
18275	SealSmart RCA Conns, RGB 23 AWG, Gold Plate (25)	42		
18280	SealSmart RCA Conns, RGB 25 AWG, Ni Plate (25)	42		
18285	SealSmart RCA Conns, RGB 25 AWG, Gold Plate (25)	42		
18301	F Connector Coupler F81 (25)	43, 79, 86		
18301C	F Connector Coupler F81 (2)	43		
18303	BNC Female-to-F Female Adapter (25)	43, 79		
18303C	BNC Female-to-F Female Adapter (2)	43, 80		
18305	BNC Female-to-F Male Adapter (25)	43, 79		
18305C	BNC Female-to-F Male Adapter (2)	43		
18306C	F Male 75 Ohm Terminator (2)	43		
18307	F Male-to-F Male Splice (25)	43		
18307C	F Male-to-F Male Splice (2)	43		
18308	BNC Inline Splice Female-to-Female (25)	43		
18308C	BNC Inline Splice Female-to-Female (2)	43		
18309	F Male 75 Ohm Terminator (25)	43		
18309C	F Male 75 Ohm Terminator (10)	43		
18310	BNC Male-to-F Female (25)	43		
18310C	BNC Male-to-F Female (2)	43		
18311	SealSmart F Conns, RG11, Ni Plate (25)	40		
18312	SealSmart F Conns, RG11, Ni Plate (4)	40		
18314	RCA Male-to-BNC Female (25)	43		
18314C	RCA Male-to-BNC Female (2)	43		
19001C	6-in-1 Screwdriver	36		
19002C	PRO 6-in-1 Screwdriver	36		
19003C	PRO 6-in-1 Security Screwdriver	36		
19059C	Can Wrench	33		
19101	Precision Screwdriver Set	38		
19103	Micro Mini II Screwdriver Set	39		
19105	22-in-1 Security Screwdriver Kit	37, 97		
19110	1 KV Insulated Precision Screwdriver Set	39		
19120C	8-in-1 Ratcheted Stubby Screwdriver	37		
19130C	Security Bit Set, 30 pc	35		
19501	BongoTies	65		
202044J	ezEX-RJ45 Conns, ezEX44, (100)	45		
202048J	ezEX-RJ45 Conns, ezEX48, (100)	45		
202050J	ezEX-RJ45 Conns, ezEX44, (Internal Ground) (50)	45		
202051J	ezEX-RJ45 Conns, ezEX44, (External Ground) (50)	45		
202052J	ezEX-RJ45 Conns, ezEX48, (External Ground) (50)	45		
21025C	RJ45 Port Saver	86		
28001J	SealSmart F Conns, RG6Q, Ni Plate (75)	40		
28006J	SealSmart F Conns, RG6, Ni Plate (75)	40		
28011J	SealSmart F Conns, RG59, Ni Plate (75)	40		
28038J	SealSmart BNC Conns, RG6, Ni Plate (40)	41		
28041J	SealSmart BNC Conns, RG59, Ni Plate (40)	41		
28051J	SealSmart RCA Conns, RG6, Ni Plate (50)	42		
28060J	SealSmart RCA Conns, RG59, Ni Plate (50)	42		
28110J	UR Telecom Splice (200)	33, 43		
90121	Basic Twisted Pair & Coax Kit	95		
90122	Twisted Pair Termination Kit	92		
90124	PRO Twisted Pair & Coax Termination Kit	95		
90125	SealSmart Field Install Kit, Ni	97		
90126	SealSmart Field Install Kit, Gold	97		
90136	EZ-RJ45 Termination Kit	94		
90140	EXO ezEX-RJ45 Termination Kit	88		
90141	EXO EX-RJ45 Termination Kit	88		
90148	EXO ezEX-RJ45 Termination & Test Kit	89		
90149	EXO Deluxe Termination & Test Kit	89		

90150	Basic HD Twisted Pair & Coax Kit	95
90151	EZ-RJPRO HD Termination Kit	94
90152C	PRO Punchdown Tool Kit	30, 94
90153	PRO HD Twisted Pair & Coaxial Kit	96
90170	10Gig Termination Kit	90, 91
90173	EZ-RJPRO Termination Pod	93
90201	Premier CATV Connectivity Kit	96
90202	Premier CCTV Connectivity Kit	96
90203	Premier Data Connectivity Kit	92
100002	EZ-RJ45 Convenience Pack (200)	92
100003B	EZ-RJ45 Cat5e (100 Box)	46
100003C	EZ-RJ45 Cat5e (50)	46
100004BL	Replacement Blade (2) for P/N 100004C	18
100004C	EZ-RJ45 Crimp Tool	18
100005	EZ-RJ45 Convenience Pack (50)	92
100007	EZ-RJPRO HD Convenience Pack	92
100008	EZ-RJ45 Combo (24)	92
100009C	EZ-RJ45 Cat6 (10)	46
100010B	EZ-RJ45 Cat6 (100 Box)	46
100010C	EZ-RJ45 Cat6 (50)	46
100011C	EZ-RJ45 Cat6 Combo Pack (30)	47
100012	EZ-RJ45 Basic Installation Kit Bundle	93
100015	EZ-RJ45 Cat5e (15)	46
100016	EZ-RJPRO HD Basic Installation Kit Bundle	93
100018C	ezEX-RJ45 Shielded Connectors, ezEX44 (10)	45
100019C	ezEX-RJ45 Shielded Connectors, ezEX48 (10)	45
100020	EZ-RJ45 Shielded Cat5e/6 (Internal Ground) (50)	47
100020C	EZ-RJ45 Shielded Cat5e/6 (Internal Ground) (50)	47
100021C	EZ-RJ45 Shielded Cat5e/6 (Internal Ground) (10)	47
100022	EZ-RJ45 Shielded Cat5e/6 (External Ground) (50)	47
100022C	EZ-RJ45 Shielded Cat5e/6 (External Ground) (50)	47
100023C	EZ-RJ45 Shielded Cat5e/6 (External Ground) (10)	47
100024C	ezEX-RJ45 Shielded Connectors, ezEX44, (Internal Ground) (50)	45
100025C	ezEX-RJ45 Shielded Connectors, ezEX44, (External Ground) (50)	45
100026B	EZ-RJ12/11 Std. Tab (100)	46
100026C	EZ-RJ12/11 Std. Tab (50)	46
100026LTB	EZ-RJ12/11 Long Tab (100)	46
100026LTC	EZ-RJ12/11 Long Tab (50)	46
100027C	ezEX-RJ45 Shielded Connectors, ezEX48, (External Ground) (50)	45
100028C	ezEX-RJ45 Shielded Connectors, ezEX44 (50)	45
100029C	ezEX-RJ45 Shielded Connectors, ezEX48 (50)	45
100030B-C	Strain Relief, Cat6, Blue (50)	50
100030BK-C	Strain Relief, Cat6, Black(50)	50
100030GR-C	Strain Relief, Cat6, Green (50)	50
100030GY-C	Strain Relief, Cat6, Grey (50)	50
100030R-C	Strain Relief, Cat6, Red (50)	50
100030Y-C	Strain Relief, Cat6, Yellow (50)	50
100031B-BG	RJ45 Boots, 5.5mm OD, Blue (25)	50
100031BK-BG	RJ45 Boots, 5.5mm OD, Black (25)	50
100031GR-BG	RJ45 Boots, 5.5mm OD, Green (25)	50
100031GY-BG	RJ45 Boots, 5.5mm OD, Grey (25)	50
100031O-BG	RJ45 Boots, 5.5mm OD, Orange (25)	50
100031P-BG	RJ45 Boots, 5.5mm OD, Purple (25)	50
100031R-BG	RJ45 Boots, 5.5mm OD, Red (25)	50
100031W-BG	RJ45 Boots, 5.5mm OD, White (25)	50
100031Y-BG	RJ45 Boots, 5.5mm OD, Yellow (25)	50
100032B-BG	RJ45 Boots, 6mm OD, Blue (25)	50
100032BK-BG	RJ45 Boots, 6mm OD, Black (25)	50
100032GR-BG	RJ45 Boots, 6mm OD, Green (25)	50
100032GY-BG	RJ45 Boots, 6mm OD, Grey (25)	50
100032O-BG	RJ45 Boots, 6mm OD, Orange (25)	50
100032P-BG	RJ45 Boots, 6mm OD, Purple (25)	50
100032R-BG	RJ45 Boots, 6mm OD, Red (25)	50
100032W-BG	RJ45 Boots, 6mm OD, White (25)	50

100032Y-BG	RJ45 Boots, 6mm OD, Yellow (25)	50
100033B-BG	RJ45 Boots, 6.5mm OD, Blue (25)	50
100033BK-BG	RJ45 Boots, 6.5mm OD, Black (25)	50
100033GR-BG	RJ45 Boots, 6.5mm OD, Green (25)	50
100033GY-BG	RJ45 Boots, 6.5mm OD, Grey (25)	50
100033O-BG	RJ45 Boots, 6.5mm OD, Orange (25)	50
100033P-BG	RJ45 Boots, 6.5mm OD, Purple (25)	50
100033R-BG	RJ45 Boots, 6.5mm OD, Red (25)	50
100033W-BG	RJ45 Boots, 6.5mm OD, White (25)	50
100033Y-BG	RJ45 Boots, 6.5mm OD, Yellow (25)	50
100034B-BG	RJ45 Boots, 7mm OD, Blue (25)	50
100034BK-BG	RJ45 Boots, 7mm OD, Black (25)	50
100034GR-BG	RJ45 Boots, 7mm OD, Green (25)	50
100034GY-BG	RJ45 Boots, 7mm OD, Grey (25)	50
100034O-BG	RJ45 Boots, 7mm OD, Orange (25)	50
100034P-BG	RJ45 Boots, 7mm OD, Purple (25)	50
100034R-BG	RJ45 Boots, 7mm OD, Red (25)	50
100034W-BG	RJ45 Boots, 7mm OD, White (25)	50
100034Y-BG	RJ45 Boots, 7mm OD, Yellow (25)	50
100037R-BG	RJ45 Boots, 7.5mm OD, Red (25)	50
100037B-BG	RJ45 Boots, 7.5mm OD, Blue (25)	50
100037BK-BG	RJ45 Boots, 7.5mm OD, Black (25)	50
100038R-BG	RJ45 Boots, 8mm OD, Red (25)	50
100038B-BG	RJ45 Boots, 8mm OD, Blue (25)	50
100038BK-BG	RJ45 Boots, 8mm OD, Black (25)	50
100039R-BG	RJ45 Boots, 8.5mm OD, Red (25)	50
100039B-BG	RJ45 Boots, 8.5mm OD, Blue (25)	50
100039BK-BG	RJ45 Boots, 8.5mm OD, Black (25)	50
100035	EZ-RJ45 Strain Relief, Cat5e, Clear (50)	47
100035C	EZ-RJ45 Strain Relief, Cat5e, Clear (50)	47
100036	EZ-RJ45 Strain Relief, Cat6, Clear (50)	47
100036C	EZ-RJ45 Strain Relief, Cat6, Clear (50)	47
100054BL	Replacement Blade Set for P/N 100054C	18
100054C	EZ-RJPRO HD Crimp Tool	18, 92, 93
100054SBL-10C	Replacement RJ45 Blades (10)	18
100055BL	Replacement Blade Set for P/N 100055C	21
100055C	PROAMP Crimp Tool	21
100061C	EXO Crimp Frame with EXO-EX Die	17
100062C	EXO Crimp Frame with EZ-RJ45 Die	16
100071C	EXO-EX Die only	17
100071BL	EXO-EX Die Blades (2)	17
100072C	EZ-RJ45 Die only	16
100072BL	EZ-RJ45 Die Blade (2)	16
100111C	Non-Impact PDT with EZ-Data Cut Blade	30
100543	EZ-RJ45 Die for P/N 100544	19
100543BL	Replacement Blade for P/N 100543	19
100543K1	EZ-Viking Field Service Kit	19
100544	EZ-Viking Crimp Tool	19
105003	EZ-RJ45 Cat5e (Bulk)	46
105004	EZ-RJ45 Cat6 (Bulk)	46
105005	EZ-RJ12/11 Std. Tab (Bulk)	46
105005LT	EZ-RJ12/11 Long Tab (Bulk)	46
105006	Strain Relief, Cat6, Red (500)	50
105007	Strain Relief, Cat6, Blue (500)	50
105008	Strain Relief, Cat6, Grey (500)	50
105009	Strain Relief, Cat6, Green (500)	50
105010	Strain Relief, Cat6, Yellow (500)	50
105011	Strain Relief, Cat6, Black (500)	50
105015	EZ-RJ45 Strain Relief, Cat5e, Clear (500)	47
105016	EZ-RJ45 Strain Relief, Cat6, Clear (500)	47
105020	EZ-RJ45 Shielded Cat5e/6 (Internal Ground) (100)	47
105022	EZ-RJ45 Shielded Cat5e/6 (External Ground) (100)	47
105024	ezEX-RJ45 Connectors, ezEX44 (500)	45
105025	ezEX-RJ45 Connectors, ezEX48 (500)	45

105027	ezEX-RJ45 Connectors, ezEX44, internal ground (100)	45	106132C	RJ12, Round/Stranded (25)	48
105028	ezEX-RJ45 Connectors, ezEX44, external ground (100)	45	106133J	RJ12, Round/Stranded (100)	48
105029	ezEX-RJ45 Connectors, ezEX48, external ground (100)	45	106135	RJ12, Round/Solid (500)	48
105060	RJ45 Boots, 5.5mm OD, Red (100)	50	106137C	RJ12, Round/Solid (25)	48
105061	RJ45 Boots, 5.5mm OD, Blue (100)	50	106138J	RJ12, Round/Solid (100)	48
105062	RJ45 Boots, 5.5mm OD, Black (100)	50	106140	RJ45 Cat5e, Flat/Stranded (500)	48
105063	RJ45 Boots, 5.5mm OD, Grey (100)	50	106142C	RJ45 Cat5e, Flat/Stranded (25)	48
105064	RJ45 Boots, 5.5mm OD, Green (100)	50	106143J	RJ45 Cat5e, Flat/Stranded (100)	48
105065	RJ45 Boots, 5.5mm OD, Yellow (100)	50	106145	RJ45 Cat5e, Round/Stranded (500)	48
105066	RJ45 Boots, 5.5mm OD, White (100)	50	106147C	RJ45 Cat5e, Round/Stranded (25)	48
105067	RJ45 Boots, 5.5mm OD, Purple (100)	50	106148J	RJ45 Cat5e, Round/Stranded (100)	48
105068	RJ45 Boots, 5.5mm OD, Orange (100)	50	106150	RJ45 Cat5e, Round/Solid (500)	48
105071	RJ45 Boots, 6mm OD, Red (100)	50	106152C	RJ45 Cat5e, Round/Solid (25)	48
105072	RJ45 Boots, 6mm OD, Blue (100)	50	106153J	RJ45 Cat5e, Round/Solid (100)	48
105073	RJ45 Boots, 6mm OD, Black (100)	50	106160	RJ45 Cat5e, Round/Stranded (500)	48
105074	RJ45 Boots, 6mm OD, Grey (100)	50	106162C	RJ45 Cat5e, Round/Stranded (25)	48
105075	RJ45 Boots, 6mm OD, Green (100)	50	106163J	RJ45 Cat5e, Round/Stranded (100)	48
105076	RJ45 Boots, 6mm OD, Yellow (100)	50	106165	RJ45 Cat5e, Round/Solid (500)	48
105077	RJ45 Boots, 6mm OD, White (100)	50	106167C	RJ45 Cat5e, Round/Solid (25)	48
105078	RJ45 Boots, 6mm OD, Purple (100)	50	106168J	RJ45 Cat5e, Round/Solid (100)	48
105079	RJ45 Boots, 6mm OD, Orange (100)	50	106170	RJ45 Cat6, Round/Stranded (500)	49
105081	RJ45 Boots, 6.5mm OD, Red (100)	50	106172C	RJ45 Cat6, Round/Stranded (25)	49
105082	RJ45 Boots, 6.5mm OD, Blue (100)	50	106173J	RJ45 Cat6, Round/Stranded (100)	49
105083	RJ45 Boots, 6.5mm OD, Black (100)	50	106175	RJ45 Cat6, Round/Solid (500)	48
105084	RJ45 Boots, 6.5mm OD, Grey (100)	50	106177C	RJ45 Cat6, Round/Solid (25)	48
105085	RJ45 Boots, 6.5mm OD, Green (100)	50	106178J	RJ45 Cat6, Round/Solid (100)	48
105086	RJ45 Boots, 6.5mm OD, Yellow (100)	50	106180C	RJ45 Cat5e, Round/Stranded (100)	48
105087	RJ45 Boots, 6.5mm OD, White (100)	50	106182C	RJ45 Cat5e, Round/Stranded (50)	48
105088	RJ45 Boots, 6.5mm OD, Purple (100)	50	106183C	RJ45 Cat5e, Round/Stranded (10)	48
105089	RJ45 Boots, 6.5mm OD, Orange (100)	50	106185	RJ45 Cat6, Round/Solid, High-Performance (500)	48
105091	RJ45 Boots, 7mm OD, Red (100)	50	106187C	RJ45 Cat6, Round/Solid, High-Performance (25)	48
105092	RJ45 Boots, 7mm OD, Blue (100)	50	106188J	RJ45 Cat6, Round/Solid, High-Performance (100)	48
105093	RJ45 Boots, 7mm OD, Black (100)	50	106190	RJ45 Cat6A 10Gig (100)	48
105094	RJ45 Boots, 7mm OD, Grey (100)	50	106191	RJ45 Cat6A 10Gig (25)	48
105095	RJ45 Boots, 7mm OD, Green (100)	50	106192	RJ45 Cat6A 10Gig (50)	48
105096	RJ45 Boots, 7mm OD, Yellow (100)	50	106192C	RJ45 Cat6A 10Gig (50)	48
105097	RJ45 Boots, 7mm OD, White (100)	50	106193C	RJ45 Cat6A 10Gig (10)	48
105098	RJ45 Boots, 7mm OD, Purple (100)	50	106194	RJ45 Cat6A 10Gig Liners (50)	48
105099	RJ45 Boots, 7mm OD, Orange (100)	50	106195	RJ45 Cat6A 10Gig Connectors (100)	49
105100	RJ45 Boots, 7.5mm OD, Blue (100)	50	106197	RJ45 Cat6A 10Gig Connectors (50)	49
105101	RJ45 Boots, 7.5mm OD, Black (100)	50	106197C	RJ45 Cat6A 10Gig Connectors (50)	49
105102	RJ45 Boots, 7.5mm OD, Red (100)	50	106198C	RJ45 Cat6A 10Gig Connectors (10)	49
105103	RJ45 Boots, 8mm OD, Blue (100)	50	106205	RJ45 Cat6, Round/Solid, Shielded High-Performance (100)	48
105104	RJ45 Boots, 8mm OD, Black (100)	50	106206J	RJ45 Cat6, Round/Solid, Shielded High-Performance (100)	48
105105	RJ45 Boots, 8mm OD, Red (100)	50	106207C	RJ45 Cat6, Round/Solid, Shielded High-Performance (50)	48
105106	RJ45 Boots, 8.5mm OD, Blue (100)	50	106208C	RJ45 Cat6, Round/Solid, Shielded High-Performance (10)	48
105107	RJ45 Boots, 8.5mm OD, Black (100)	50	106211C	In-Line Coupler, Light Almond (2)	53
105108	RJ45 Boots, 8.5mm OD, Red (100)	50	106220	Cat6A Flex Connectors, Non-Shielded (1)	44
106100	RJ22, Flat/Stranded (500)	48	106230	Cat6A Flex Connectors, Shielded (1)	44
106102C	RJ22, Flat/Stranded (25)	48	202003J	EZ-RJ45 Cat5e (100)	46
106103J	RJ22, Flat/Stranded (100)	48	202010J	EZ-RJ45 Cat6 (100)	46
106110	RJ11, Flat/Stranded (500)	48	202015J	EZ-RJ45 Cat5e 50/50 Combo (50 Each)	47
106112C	RJ11, Flat/Stranded (25)	48	202016J	EZ-RJ45 Cat6 50/50 Combo (50 Each)	47
106113J	RJ11, Flat/Stranded (100)	48	202020J	EZ-RJ45 Shielded Cat5e/6, Internal Ground (50)	47
106115	RJ11, Round/Stranded (500)	48	202022J	EZ-RJ45 Shielded Cat5e/6, External Ground (50)	47
106117C	RJ11, Round/Stranded (25)	48	202026J	EZ-RJ11/12 Std. Tab (100)	46
106118J	RJ11, Round/Stranded (100)	48	202035J	EZ-RJ45 Strain Relief, Cat5e, Clear (100)	47
106120	RJ11, Round/Solid (500)	48	202036J	EZ-RJ45 Strain Relief, Cat6, Clear (100)	47
106122C	RJ11, Round/Solid (25)	48	202044J	ezEX-RJ45 Connectors, ezEX44 (100)	45
106123J	RJ11, Round/Solid (100)	48	202048J	ezEX-RJ45 Connectors, ezEX48 (100)	45
106125	RJ12, Flat/Stranded (500)	48	202050J	ezEX-RJ45 Connectors, ezEX44, Internal Ground (50)	45
106127C	RJ12, Flat/Stranded (25)	48	202051J	ezEX-RJ45 Connectors, ezEX44, External Ground (50)	45
106128J	RJ12, Flat/Stranded (100)	48	202052J	ezEX-RJ45 Connectors, ezEX48, External Ground (50)	45
106130	RJ12, Round/Stranded (500)	48	HPH16-25	HPH High-Performance J-Hook, Standard, 1" (25)	60



HPH16AC-25	HPH High-Performance J-Hook, 90°, 1" (25)	60
HPH16W-25	HPH High-Performance J-Hook, Batwing, 1" (25)	60
HPH32-25	HPH High-Performance J-Hook, Standard, 2" (25)	60
HPH32AC-25	HPH High-Performance J-Hook, 90°, 2" (25)	60
HPH32W-25	HPH High-Performance J-Hook, Batwing, 2" (25)	60
HPH48-25	HPH High-Performance J-Hook, Standard, 3" (25)	60
HPH48AC-25	HPH High-Performance J-Hook, 90°, 3" (25)	60
HPH48W-25	HPH High-Performance J-Hook, Batwing, 3" (25)	60
HPH64-25	HPH High-Performance J-Hook, Standard, 4" (25)	60
HPH64AC-25	HPH High-Performance J-Hook, Batwing, 4" (25)	60
HPH64W-25	HPH High-Performance J-Hook, Batwing, 4" (25)	60
JH12-25	J-Hook, Standard, 3/4" Size 12 (25)	61
JH12-100	J-Hook, Standard, 3/4" Size 12 (100)	61
JH12AC-25	J-Hook, 90° Standard, 3/4" Size 12 (25)	61
JH12AC-100	J-Hook, 90° Standard, 3/4" Size 12 (100)	61
JH12ACFM24-100	J-Hook, Hammer-On, Swivels 360°, 3/4" Size 12, for 1/8"-1/4" flange (100)	61
JH12ACFM58-100	J-Hook, Hammer-On, Swivels 360°, 3/4" Size 12, for 5/16"-1/2" flange (100)	61
JH12ACSSBC-100	J-Hook, Spring Steel Beam Clamp, 3/4" Size 12, for 1/8"-1/2" flange (100)	61
JH12BC-100	J-Hook, Beam Clamp, Swivels 360°, 3/4" Size 12, for 1/8"-1/2" flange (100)	61
JH12HOK24-100	J-Hook, Hammer-On, 3/4" Size 12, for 1/8"-1/4" flange (100)	61
JH12HOK58-100	J-Hook, Hammer-On, 3/4" Size 12, for 5/16"-1/2" flange (100)	61
JH12W-25	J-Hook, Batwing Standard, 3/4" Size 12 (25)	61
JH12W-100	J-Hook, Batwing Standard, 3/4" Size 12 (100)	61
JH21-25	J-Hook, Standard, 1 5/16" Size 21 (25)	61
JH21-100	J-Hook, Standard, 1 5/16" Size 21 (100)	61
JH21AC-25	J-Hook, 90° Standard, 1 5/16" Size 21 (25)	61
JH21AC-100	J-Hook, 90° Standard, 1 5/16" Size 21 (100)	61
JH21ACFM24-100	J-Hook, Hammer-On, Swivels 360°, 1 5/16" Size 21, for 1/8"-1/4" flange (100)	61
JH21ACFM58-100	J-Hook, Hammer-On, Swivels 360°, 1 5/16" Size 21, for 5/16"-1/2" flange (100)	61
JH21ACSSBC-100	J-Hook, Spring Steel Beam Clamp, 1 5/16" Size 21, for 1/8"-1/2" flange (100)	61
JH21BC-100	J-Hook, Beam Clamp, Swivels 360°, 1 5/16" Size 21, for 1/8"-1/2" flange (100)	61
JH21HOK24-100	J-Hook, Hammer-On, 1 5/16" Size 21, for 1/8"-1/4" flange (100)	61
JH21HOK58-100	J-Hook, Hammer-On, 1 5/16" Size 21, for 5/16"-1/2" flange (100)	61
JH21W-25	J-Hook, Batwing Standard, 1 5/16" Size 21 (25)	61
JH21W-100	J-Hook, Batwing Standard, 1 5/16" Size 21 (100)	61
JH32-25	J-Hook, Standard, 2" Size 32 (25)	61
JH32-100	J-Hook, Standard, 2" Size 32 (100)	61
JH32AC-25	J-Hook, 90° Standard, 2" Size 32 (25)	61
JH32AC-100	J-Hook, 90° Standard, 2" Size 32 (100)	61
JH32ACFM24-100	J-Hook, Hammer-On, Swivels 360°, 2" Size 32, for 1/8"-1/4" flange (100)	61
JH32ACFM58-100	J-Hook, Hammer-On, Swivels 360°, 2" Size 32, for 5/16"-1/2" flange (100)	61
JH32ACSSBC-100	J-Hook, Spring Steel Beam Clamp, 2" Size 32, for 1/8"-1/2" flange (100)	61
JH32BC-100	J-Hook, Beam Clamp, Swivels 360°, 2" Size 32, for 1/8"-1/2" flange (100)	61
JH32HOK24-100	J-Hook, Hammer-On, 2" Size 32, for 1/8"-1/4" flange (100)	61
JH32HOK58-100	J-Hook, Hammer-On, 2" Size 32, for 5/16"-1/2" flange (100)	61

JH32W-25	J-Hook, Batwing Standard, 2" Size 32 (25)	61
JH32W-100	J-Hook, Batwing Standard, 2" Size 32 (100)	61
JH64-25	J-Hook, Standard, 4" Size 64 (25)	61
JH64AC-25	J-Hook, 90° Standard, 4" Size 64 (25)	61
JH64ACFM24-25	J-Hook, Hammer-On, Swivels 360°, 4" Size 64, for 1/8"-1/4" flange (25)	61
JH64ACFM58-25	J-Hook, Hammer-On, Swivels 360°, 4" Size 64, for 5/16"-1/2" flange (25)	61
JH64ACSSBC-25	J-Hook, Spring Steel Beam Clamp, 4" Size 64, for 1/4"-1/2" flange (25)	61
JH64BC-25	J-Hook, Beam Clamp, Swivels 360°, 4" Size 64, for 1/8"-1/2" flange (25)	61
JH64HOK24-25	J-Hook, Hammer-On, 4" Size 64, for 1/8"-1/4" flange (25)	61
JH64HOK58-25	J-Hook, Hammer-On, 4" Size 64, for 5/16"-1/2" flange (25)	61
JH64W-25	J-Hook, Batwing Standard, 4" Size 64 (25)	61
JH701	Female Hex Adapter for 1/4" Male Driver	64, 65
JH702	Hex Adapter, Open End 3/8"	64, 65
JH703	Hex Adapter, Female Open End 5/8"	64, 65
JH705	1/2" NPT Adapter	64, 65
JH707	Drill Driver Adapter	64, 65
JH711	Keyless Chuck Adapter, 3/8"	64, 65
JH712	Xtender Pole – 12	64
JH718	Xtender Pole – 18	64
JH802-100	Bridle Rings, 10x24 – 3/4" ID	63
JH804-100	Bridle Rings, 10x24 – 2" ID	63
JH807-100	Bridle Rings, 0.25x20 – 1.1/4" ID	63
JH808-100	Bridle Rings, 0.25x20 – 2" ID	63
JH809-50	Bridle Rings, 0.25x20 – 4" ID	63
JH813-100	Bridle Rings, 0.25 Wood Screw – 1.25" ID	63
JH814-100	Bridle Rings, 0.25 Wood Screw – 2" ID	63
JH901-100	Vertical Overhang (C Purlin) (100)	62, 63
JH902-100	Angled Overhang (Z Purlin) (100)	62, 63
JH910-100	Hammer-On Beam Clamp, 1/8-1/4" (100)	62, 63
JH911-100	Hammer-On Beam Clamp, 5/16-1/2" (100)	62, 63
JH915	Spring Steel Hammer-On Beam Clamp for 1/8"-1/4" flange	62, 63
JH916	Spring Steel Hammer-On Beam Clamp for 5/16"-1/2" flange	62, 63
JH920-100	Angle Clip 90° 1/4-20 (100)	62, 63
JH930-100	Angle Clip 90 – End Hook, Powder Actuated Nail (100)	62, 63
JH932-100	Angle Clip 90 – Powder Actuated Nail (100)	62, 63
JH940-100	1/4" Eye Lag Screw (100)	62, 63
JH941-100	2" Overall Self Drill Eye Lag Screw (100)	62, 63
JH960-100	Multi-Function Clip, Batwing (100)	62, 63
JH965-50	Pressed Beam Clamp for 1/2" Flanges (50)	62, 63
JH966-100	Beam Clamp for 1/8"-1/2" Flange (100)	62, 63
JH967-100	Beam Clamp for 1/8"-1/2" Flange (100)	62, 63
JH975	Installation Tool – Vertical & Angled Overhang	62, 63, 64, 65
JH980	Eye Lag Driver	62, 63
T101C	Coax Remote Kit for 4MAPPER	79, 86
T103C	BNC Adapter Kit	79, 86
T104C	4MAPPER Tester	79, 82
T120C	ID Only Coax Remotes, #1-19	86
T121C	ID Only Network Remotes, #1-19	86
T124C	Master Remote	86
T125C	RJ45 to Alligator 12" Cable	86
T126C	No-Fault, RJ12 Cable	86
T127C	ID Only Coax Remotes, #1-8	86
T128C	ID Only Network Remotes, #1-12	86
T129	VDV MapMaster 2.0 Tester	74, 83
T129K1	VDV MapMaster 2.0 Test Kit	74, 83
T130	VDV MapMaster 3.0 Cable Tester	72, 83
T130K1	VDV MapMaster 3.0 Cable Tester Kit	73
T130K2	VDV MapMaster 3.0 Cable Tester PRO Kit	73

T130K3	VDV MapMaster 3.0 Cable Tester Deluxe PRO Kit	73
T138	Cable Tester Smart Remotes, #1-8, Case	87
T139	Cable Tester Smart Remotes, #2-8, Case	87
T301C	110V Outlet Tester	85
T302C	GFCI Socket Tester	85
T305C	AC Voltage Detector	85
T62	RECON Test Set	75
TAD001	F Connector Coupler	43, 80
TAK010	Hanging Strap w/Carabineer Clip	87
TAK020	Prowler Kickstand	87
TAK030	Network Accessory Kit	86
TAR104	Net Chaser Active Remote	86
TCA001	Cable Assembly, Insulated Push-On F to RJ45 Plug	80
TCA002	Cable Assembly, Insulated BNC to Alligator Clips	80
TCA003	Cable Assembly, Insulated Push-On F to Alligator Clips	80
TCA004	Cable Assembly, Screw-On F Jack to Push-On F Plug, 12"	86
TCA007	Micro USB Cable	86
TCA015	Cable Assembly, 24, 8-Way Alligator Clips to RJ45	86
TCA016	Network Patch Cable, 12" Cat5e FTP	86
TCB300	Cable Prowler Cable Test Kit	71, 83
TCB400	Cable Prowler Deluxe PRO Test Kit	71
TCB360K1	Cable Prowler PRO Test Kit	70, 83
TCC200	Coax Clarifier with 2 Coax RF Remotes Kit	78, 82
TCC220	Coax Clarifier with 4 Coax RF Remotes Kit	78, 82
TFT100	Fault Trapper Tester	84
TG210C	ToneMaster High-Powered Tone Generator w/Alligator Clips	77
TG210K1	ToneMaster w/Alligator Clips and ToneSeeker Set, Hip Pouch	77
TG220C	ToneMaster High-Powered Tone Generator w/Angled Bed-of-Nails Clips	77
TG220K1	ToneMaster w/Angled Bed-of-Nails and ToneSeeker Set, Hip Pouch	77
TNC950AR	Net Chaser Ethernet Speed Certifier Tester Kit	66, 83
TNC950DX	Deluxe Net Chaser Tester Kit	67
TNP700	Net Prowler Network Test Kit	69, 83
TNP800	Net Prowler Deluxe PRO Test Kit	69
TNP850K1	Net Prowler PRO Test Kit	68, 83
TP150	Tone and Probe Set	76, 81
TP250C	ToneSeeker Tone Tracer Probe	77
TP500C	LANSeeker Cable Tester	76, 83
TP500MRC	LANSeeker Master Remote	76, 86
TPS100C	PoE Detector	81
TPS120	Power Supply for Net Chaser	87
TRK120	ID Only Coax Remotes, #1-20	86
TRK220	ID Only Network Remotes, #1-20	86
TSS200	Snap Shot Tester	80, 82

## Alpha Index

110 EZ-Data Cut Blade	30
4MAPPER Tester	79
Bongo Ties	65
BR1 Multi-Stripper	13
Bridle Rings	63
Cable Jacket Slitters	9
Cable Prowler Test Kits	70, 71
Cable Tie Gun	33
Can Wrench	33
Cat6A Flex Connectors	44
Coax Clarifier Tester	78
Coax Adapters	43
Compression Connectors	40, 41, 42, 43, 44, 45, 46
Connector Removal Tools	34, 35
Cyclops Stripper	13

E Series Coax Strippers	15
EX0 Crimpers	16, 17
EX0 Termination Kits	88, 89
ezEX-RJ45 Connectors	45
EZ-RJ12/11 Connectors	46
EZ-RJ45 Connectors	46, 47
EZ-RJ45 Crimp Tools	18, 19
EZ-SnapJacks	55
EZ-Viking Crimp Tool	19
Fault Trapper Tester	84
J Hooks and J Hook Hardware	60, 61, 62
Kits, Coax	95, 96
Kit, Connectivity	92
Kit, Convenience Packs	92
Kits, Field Installation	97
Kit, Installation Bundles	93
Kits, Termination	92, 93, 94, 95
Kit, 10Gig Termination	90, 91
Kit, Twisted Pair Termination	92
Keystone Blank Inserts	53
Keystone Coupler	53
Keystone Jacks	52, 53
LanSeeker Cable Tester	76
Maxim Strippers	10
Minim Stripper	11
Net Chaser Ethernet Speed Certifier Tester	66, 67
Net Prowler Test Kits	68, 69
Patch Panels	56, 57, 58, 59
PoE Detector	81
PRO-Strike Punchdown Tool	28
PROAMP Crimp Tool	21
PRO Drywall Saw	34
PT Punchdown Tool	30, 94, 95, 96
ProStrip 25R Coax Stripper	15
ProStrip Wire Strippers	11
Punchdown Blades	29
RECON Test Set	75
RJ11/12 Connectors	48
RJ22 Connectors	48
RJ45 Boots	50
RJ45 Cat6A 10Gig Connectors	49
RJ45 Connectors	48, 49
Screwdriver Sets	36, 37, 38, 39, 97
SealSmart Compression Connectors	40, 41, 42
SealSmart Crimp Tools	22, 23
SealSmart Coax Strippers	14
Smart Remote Kit	87
Snap Shot Tester	80
Strain Reliefs, Color Coded	50
Strain Reliefs, EZ Snag Proof	47
Telecom Splicing Connectors	43
Telecom Pliers	32
Tele-Titan Crimp Tool	21
Tele-TitanXG Crimp Tool	19
Tele-TitanXG 2.0 Crimp Tool	20
Tester Accessories	86, 87
Tone and Probe Set	81
ToneMaster	77
ToneSeeker	77
VDV MapMaster 2.0	74
VDV MapMaster 3.0	72, 73
Wall Plates	54
XTender Pole & Accessories	64, 65

## EZ-RJ45® Termination

Wire	1	2	3	4	5	6	7	8
T568A	White/Green	Green	White/Orange	Blue	White/Blue	Orange	White/Brown	Brown
T568B	White/Orange	Orange	White/Green	Blue	White/Blue	Green	White/Brown	Brown

1) Remove 1 1/2" to 2" of your cable jacket from your cable using the Cat5e/6 Cable Jacket Stripper, P/N 15015. Rotate stripper 1 to 2 turns, enough to score the jacket without cutting through it, to prevent nicking the conductors.



2) Bend the cable where it is scored and the cable jacket will 'pop' and break away. Remove it but do NOT throw it away. This is your FREE pair separator!

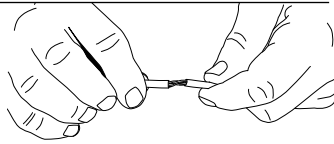

3) Separate pair ends at tip. Place your free pair separator over one of the conductor ends of each pair and push/rotate in opposite direction of the twist, separating each pair.

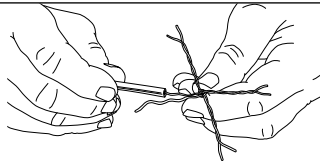

4) Straighten each pair, removing all the bends/kinks.

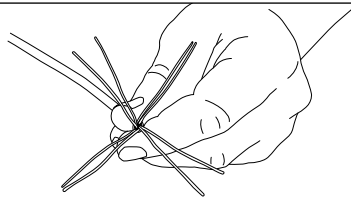

5) Determine whether you will be using the T568A or T568B configuration (above) and organize wires accordingly. Line up your wires and make a clean cut across all 8 conductors with P/N 10517 leaving approximately 1.5" of wire protruding from the jacket.

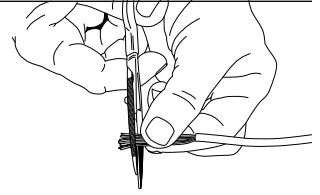

6) Slide the connector onto the wires snugging it up to the jacket. **Cat5e:** Be sure to insert cable jacket beyond the primary strain latch to ensure twists are less than 1/2" from the point of termination. **Cat6:** Be sure to insert cable jacket all the way up and behind the contacts to assure twists are less than 3/16" from the point of termination.

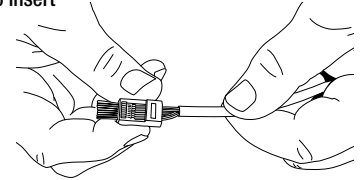

7) Crimp and trim the connector in one EZ process with P/N 100054 or 100062C.

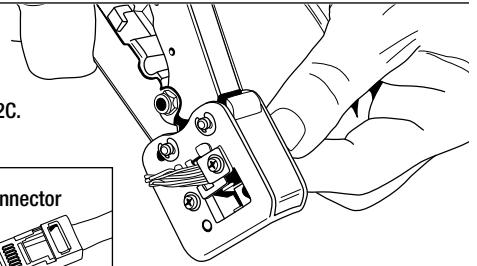

7) Crimp and trim the connector in one EZ process with P/N 100054 or 100062C.

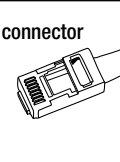

87654321



Contact Identification  
Front end of EZ Connector

## Terminating Connectors is as EZ as 1-2-3!

**1** Strip and prepare cable slide conductors straight through EZ Connector

Pin 1 T568A

**2** Verify proper wiring order

T568A / T568B Wiring Chart

Wire	1	2	3	4	5	6	7	8
T568A	W/G	G	W/O	BL	W/BL	O	W/BR	BR
T568B	W/O	O	W/G	BL	W/BL	G	W/BR	BR

**3** Crimp connector and trim excess wire in one step with the EZ-RJ45® Crimp Tool!

## US/Metric Conversions

### Wire Gauge Equivalents

AWG	=	mm <sup>2</sup>
32	=	0.03
30	=	0.05
28	=	0.08
26	=	0.10
24	=	0.20
22	=	0.34
20	=	0.50
18	=	0.75
None	=	1.00
16	=	1.50
14	=	2.50
12	=	4.00
10	=	6.00
8	=	10
6	=	16
4	=	25
2	=	35
1/0	=	50
2/0	=	70
3/0	=	80
4/0	=	96-116
250 MCM	=	127
300 MCM	=	152
350 MCM	=	177
400 MCM	=	203
500 MCM	=	240
600 MCM	=	300
750 MCM	=	400
1500 MCM	=	800
2000 MCM	=	1000

### Conversions

1 Inch	=	25.4 mm
1 Inch	=	2.54 cm
0.0394 Inch	=	1 mm
0.394	=	1 cm
1 Ounce	=	28.5 Grams
Degrees C	=	(Degrees F - 32) x 5/9
Degrees F	=	(Degrees C x 9/5) + 32
1 Newton (force)	=	4.448 lbs. (force)
1 lb. (force)	=	0.2248 Newtons (force)

## Tips & Tricks

**How to use your tools** is just as important as what tool you choose for a specific application. Look for this icon throughout our catalog for field-proven ways to work smarter, faster, and safer.

Have a "Tip & Trick" of your own? Want to share your idea? E-mail us at [info@platinumtools.com](mailto:info@platinumtools.com).

Tip & Trick	Pg.
Give It The Boot	7
Measuring Twisted Pair Cable Length	36
Reshaping The BIG Stuff	38
Combing Your Braid	41
Listen To Your Stripper	42
T568A / T568B Wiring Chart	46



## Tip & Ring Chart

**Going to wire your phone system** with either Cat5e or Cat6 cable, but not sure what the correct color code is? This Tip & Ring Chart will help give you the right answers!

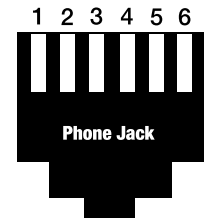

Contact Position	RJ12 (RJ25) 6P6C	RJ11 (RJ14) 6P6C	RJ11 6P2C	Pair	Tip (T) & Ring (R)	Pos (+) & Neg (-)	Cat5e & Cat6	New Color Code	Old Color Code
1	1			3	T	+	W/GR	W/GR	White
2	2	1		2	T	+	W/OR	W/OR	Black
3	3	2	1	1	R	-	BL	BL/W	Red
4	4	3	2	1	T	+	W/BL	W/BL	Green
5	5	4		2	R	-	OR	OR/W	Yellow
6	6			3	R	-	GR	GR/W	Blue

**©2017 Platinum Tools, Inc. All rights reserved.**

The following marks are trademarks of Platinum Tools, Inc.: EZ-RJPRO HD, Net Prowler, Cable Prowler, Net Chaser, "We Make Connections EZ!," SealSmart, Tele-Titan, Tele-TitanXg, EZ-Viking, PROAMP, PRO-Strike, Xtender Pole, VDV MapMaster, 4MAPPER and RECON.

The following marks are referenced: EXO Crimp Frame, ezEX-RJ45, ezEX, EXO, EXO-EX Die, EZ-RJ45, 110 EZ-Data Cut Blade and JackAX are trademarks of SullStar Technologies, Inc.; Coax Clarifier and Snap Shot are trademarks of T3 Innovation; AMP is a trademark of TE Connectivity, Ltd. Company; Kevlar is a trademark of DuPont; BIX is a trademark of Nortel; Krone is a trademark of Krone, Inc.; Maxim, Minim and Cyclops are trademarks of Tavismanor, Ltd.; BongoTies is a trademark of Gyroscope Interactive; Torx is a trademark of Camcar Corp.; Elco is a trademark of Merloni Brands KFT; HangerMate is a trademark of Acument Intellectual Propertiers, LLC.; Sammy Super Screws is a trademark of ITW Buildex & Illinois Tool Works, Inc.; Powers Vertigo is a trademark of Powers Fasteners, Inc.; SC is a trademark of NTT Advanced Technology; ST is a trademark of American Telephone & Telegraph Company; Velcro is a trademark of Velcro Industries B.V. Other products, logos and company names mentioned herein may be trademarks of their respective owners.

Reference dimensions in this catalog are shown in inches, millimeters, or both, and are for reference purposes only. For precise and specific dimensional requirements, contact the factory.

Products in this catalog have been manufactured and engineered primarily with the US market in mind. The largest percentage of these products will be saleable in the European market, but we make no claims that they meet all European requirements. If compliance is questioned per a regulation or standard on any particular product, contact your authorized Platinum Tools Distributor or your local Representative for Platinum Tools or email your Platinum Tools Team: [info@platinumtools.com](mailto:info@platinumtools.com).

We believe the information in this catalog at the time of printing was accurate and reliable to the best of our expertise and knowledge. Its intention is to act as a guide with product(s) selection. It is not a technical reference manual or is it intended to be used as one. We do not assume any liability for any occurrence due to said use. This catalog supersedes and voids all previous catalogs.

We warranty our products to be free from defects of material and workmanship, under normal service and use, for a minimum of one year or as otherwise stated in either catalog or packaging. Platinum Tools will not be liable for any misuse or modification of its product(s) by the purchaser or purchaser's agent. Said misuse or modification will void warranty.

---

Platinum Tools, Inc.  
2450 Turquoise Circle  
Newbury Park, CA 91320  
USA

Phone: **800.749.5783**

Fax: **800.749.5784**

**[www.platinumtools.com](http://www.platinumtools.com)**  
**[info@platinumtools.com](mailto:info@platinumtools.com)**

Catalog design and production by Sundberg Design  
[sundberg@sundbergdesign.com](mailto:sundberg@sundbergdesign.com)

**We Make Connections EZ!**

2450 Turquoise Circle  
Newbury Park, CA 91320  
USA



Phone: **800.749.5783**  
Fax: **800.749.5784**

[www.platinumtools.com](http://www.platinumtools.com)  
[info@platinumtools.com](mailto:info@platinumtools.com)

