

# XTND4K100TPC

Product code: XTND4K100TPC  
HDMI 2.0 / HDBaseT 2.0 18Gbps HDR Extender

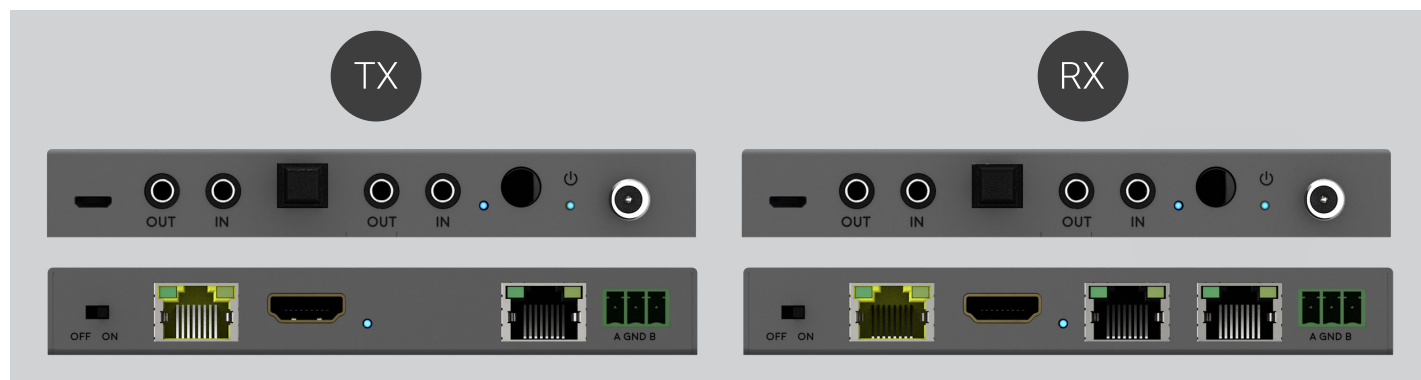

A long-range HDMI 2.0 / HDBaseT 2.0 extender set - supports 18Gbps premium UHD/4K 60Hz 4:4:4 data rates, with all current HDR formats inc. Dolby Vision®, HDR10 and HLG up to 100 metres, over one twisted pair Cat cable. The extender features useful audio return connectivity via HDMI-ARC, Optical or two-way stereo.

Control via two-way IR, RS232 and two 10/100 LAN data ports are also available on the receiver. Tipping Point Compression enables the transmission of 18Gbps content via HDBaseT 2.0 technology, with no human-perceivable difference in video quality. TPC can handle all HDR formats, including Dolby Vision, retaining all original HDR Meta and is compatible with all chroma subsampling and colour space options (4:4:4, 4:2:2, and 4:2:0).

## FEATURES

HDMI® 2.0 (a/b) HDCP 2.2 compliant
18Gbps data rate throughout (up to 100m)
Long-range mode allows for 1080p up to 150m
Supports all resolutions up to and inc. Ultra HD 4K 60 4:4:4
Supports all current High Dynamic Range (HDR) formats inc. Dolby Vision®
Supports all current audio formats up to Dolby Atmos® and DTS:X®
RX>TX audio return via Optical or HDMI-ARC to Optical on TX
Bi-directional stereo transmission
Bi-directional PoH - can be powered from either RX or TX.
2x integrated 10/100 Ethernet LAN connections at RX
Sold as a complete install package, with all IR cabling and mounting kit included.
UK / EU / AU / US multi-territory adapters included

## SPECIFICATIONS



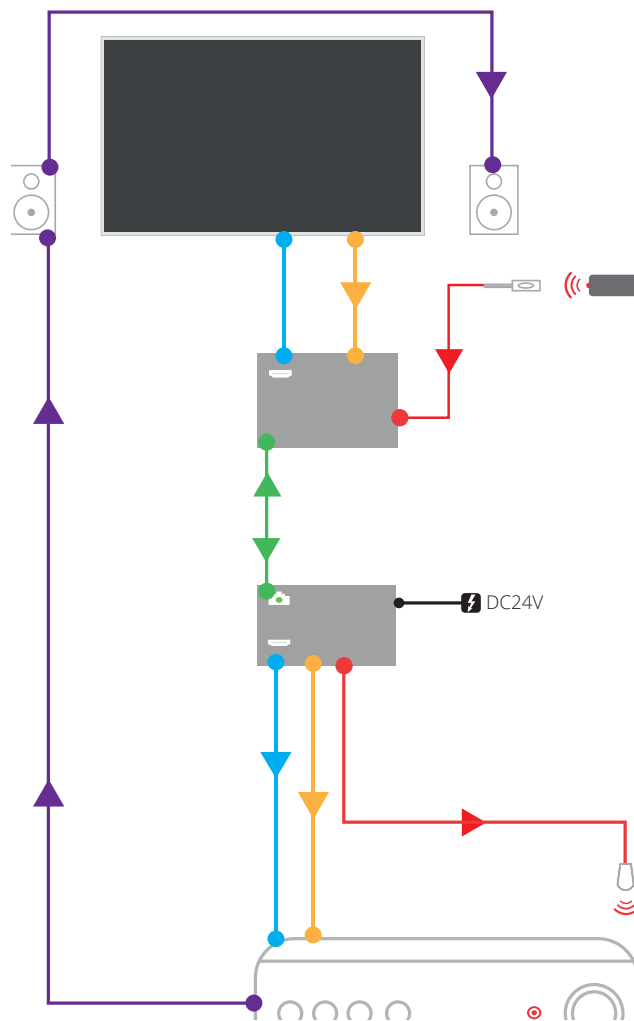

TX / RX form factor	Lightweight slender aluminium enclosure
Inputs / outputs	TX HDMI in / RJ45 HDBaseT out / RJ45 LAN (10/100) / 2x Stereo 3.5mm jacks (in/out) / Optical out / RS232 / 2x IR 3.5mm jack (in = to RX / out = from RX)
Inputs / outputs	RX RJ45 HDBaseT in / HDMI out / 2x RJ45 LAN (10/100) / 2x Stereo 3.5mm jacks (in/out) / Optical out / RS232 / 2x IR 3.5mm jack (in = to TX / out = from TX)
Transmission tech.	HDBaseT 2.0 Class C + TPC
Video bandwidth	594MHz clock / 18Gbps data
ESD protection	± 8kV (air-gap discharge) ± 4kV (contact discharge)
Control	Bi-directional IR, RS232, LAN + HDMI-CEC pass through.
Device / Package weight	176 / 1100 g
Dimensions (W/D/H)	127 / 110 / 17 mm (TX and RX)
Power	24V/1A DC screw type connector
Operating temperature	32°F to 104°F (0°C to 40°C)
Storage temperature	-4°F to 140°F (-20°C to 60°C)
Relative humidity	20~90 % RH (non-condensing)
Power consumption	9.5W (max)
Guarantee	2 year guarantee

# XTND4K100TPC

Product Code: XTND4K100TPC



## LEGEND

-  HDMI Cable
-  Optical Cable
-  IR Cable
-  Cat Cable
-  Speaker Cable